

Frame Grabber and Simulator Hardware Reference & Installation Guide

June 2024
Rev 2.0



2255 Glades Rd., Suite 324A
Boca Raton, FL 33431
USA
+1 (561) 689-2899

20 HaMesila St.
Nesher 3688520
Israel
+972 (72) 272-3500

info@kayainstruments.com
support@kayainstruments.com
www.kayainstruments.com

Table of Contents

1	Figures and Tables	2
1.1	List of figures	2
1.2	List of tables.....	3
2	Revision history.....	4
3	Introduction	5
3.1	Safety precautions.....	5
3.2	Disclaimer	6
4	Document Scope.....	7
5	Cards Overview.....	8
5.4	Komodo II Dual CoaXPress connectors and LEDs Layout	9
5.5	Komodo II Quad CoaXPress connectors and LEDs Layout	10
5.6	Komodo II Dual CLHS compatible connectors and LEDs Layout	10
5.7	Komodo II Quad CoF / Komodo II Quad CLHS compatible connectors and LEDs Layout	11
5.8	Komodo II Quad CoaXPress MXM connectors and LEDs Layout.....	11
5.9	Komodo II Quad CoaXPress PCIe104 connectors and LEDs Layout	12
5.10	Komodo III Dual CoaXPress connectors and LEDs Layout	12
5.11	Komodo III Quad CoaXPress connectors and LEDs Layout	13
5.12	Komodo III Octo CoaXPress connectors and LEDs Layout.....	13
5.13	Chameleon II CoaXPress connectors and LEDs Layout	14
5.14	Chameleon II CoF connectors and LEDs Layout	14
6	PCIe Working Modes	15
7	Card LEDs.....	16
7.1.1	Connector LEDs	16
7.1.2	Board Status LEDs.....	16
8	CoaXPress Cables	17
9	Power Connector.....	18
9.1	CoaXPress Frame Grabbers Power Connector	18
10	General Purpose Input Output	19
10.1	GPIO Connectors	19
10.2	GPIO Pinout	20
10.3	GPIO Output / Input	21
10.3.1	LVDS Inputs.....	21
10.3.2	LVDS Outputs.....	21
10.3.3	TTL Inputs/Outputs.....	22
10.3.4	LVTTL Inputs/Outputs.....	22
10.3.5	Isolated Input	23
10.3.6	Isolated Output.....	24
11	Mechanical Specifications	25
11.1	Mechanical Drawings	25
11.1.1	Predator II Single CoaXPress Mechanical Drawing	25
11.1.2	Predator II Single CoaXPress M.2 Mechanical Drawing	25
11.1.3	Predator II Single CoF / Predator II Single CLHS compatible Mechanical Drawing	26
11.1.4	Komodo II Dual CoaXPress Mechanical Drawing	26
11.1.5	Komodo II Quad CoaXPress Mechanical Drawing	27
11.1.6	Komodo II Dual CLHS compatible Mechanical Drawing.....	27
11.1.7	Komodo II Quad CoF / Komodo II Quad CLHS compatible Mechanical Drawing.....	28
11.1.8	Komodo II Quad CoaXPress MXM Mechanical Drawing	28

11.1.9	Komodo II Quad CoaXPress PCIe104 Mechanical Drawing	29
11.1.10	Komodo III Dual CoaXPress Mechanical Drawing	29
11.1.11	Komodo III Quad CoaXPress Mechanical Drawing	30
11.1.12	Komodo III Octo CoaXPress Mechanical Drawing	30
11.1.13	Chameleon II CoaXPress	31
11.1.14	Chameleon II CoF	31
12	Power Specification	32
12.1	Absolute Maximum Ratings	32
13	Installation & Configuration	33
13.1	Installation Instructions	33
13.2	CoaXPress Cards	33
13.2.1	Installing and Removing Micro-BNC Cables	33
13.3	CLHS compatible and CoF Cards	35
13.3.1	Installing & Removing SFP+ Modules	35
13.3.2	Precautions	35
13.3.3	Installing the SFP+ Module	35
13.3.4	Connecting the Interface Cable to the SFP+ Module	36
13.3.5	Removing the SFP+ Module	37
13.4	Camera Connection Topologies	38

1 Figures and Tables

1.1 List of figures

Figure 1 – Predator II Single CoaXPress connector topology	8
Figure 2 – Predator II Single CoaXPress M.2 connector topology.....	8
Figure 3 – Predator II Single CoF / Predator II Single CLHS compatible connector topology	9
Figure 4 – Komodo II Dual CoaXPress connector topology.....	9
Figure 5 – Komodo II Quad CoaXPress connector topology	10
Figure 6 – Komodo II Dual CLHS compatible connector topology	10
Figure 7 – Komodo II Quad CLHS compatible / Komodo II Quad CoF connector topology.....	11
Figure 8 – Komodo II Quad CoaXPress MXM connector topology.....	11
Figure 9 – Komodo II Quad CoaXPress PCIe104 connector topology	12
Figure 10 – Komodo II Dual CoaXPress connector topology.....	12
Figure 11 – Komodo II Quad CoaXPress connector topology	13
Figure 12 – Komodo II Octo CoaXPress connector topology	13
Figure 13 – Chameleon II CoaXPress connector topology	14
Figure 14 – Chameleon II CoF connector topology.....	14
Figure 15 – 6-pin power connector	18
Figure 16 – 2-pin power connector	18
Figure 17 – GPIO connector schematics	19
Figure 18 – LVDS inputs schematics	21
Figure 19 – LVDS outputs schematics.....	21
Figure 20 – TTL inputs/outputs schematics	22
Figure 21 – LVTTTL inputs/outputs schematics	22
Figure 22 – Isolated input schematics	23
Figure 23 – Isolated output schematics.....	24
Figure 24 – Pushing the Micro-BNC connector into place	34
Figure 25 – Twisting the connector and securing it in position	34
Figure 26 – SFP+ Module Installation.	36
Figure 27 – Interface connecting to the SFP+ Module.....	36
Figure 28 – Removing the SFP+ Module.....	37
Figure 29 – Single camera topology.....	38
Figure 30 – Dual camera topology.....	38
Figure 31 – Quad camera topology.....	38

1.2 List of tables

Table 1 – Revision History.....	4
Table 2 – PCIe working modes.....	15
Table 3 – Connector indicator lamp states	16
Table 4 – Connector indication lamp timings	16
Table 5 – Status indicator lamp states.....	16
Table 6 – Typical link performance	17
Table 7 – 6-pin Power connector pinout	18
Table 8 – 2-pin Power connector pinout	18
Table 9 – GPIO connectors part numbers.....	19
Table 10 – GPIO connector pinout.....	20
Table 11 – LVDS inputs DC characteristics.....	21
Table 12 – LVDS inputs DC & AC characteristics	21
Table 13 – LVDS outputs DC characteristics	21
Table 14 – LVDS outputs AC characteristics.....	21
Table 15 – TTL inputs/outputs DC characteristics.....	22
Table 16 – TTL inputs/outputs AC characteristics.....	22
Table 17 – LVTTTL inputs/outputs DC characteristics.....	22
Table 18 – LVTTTL inputs/outputs AC characteristics.....	23
Table 19 – Isolated input DC characteristics.....	23
Table 20 – Isolated input AC characteristics	23
Table 21 – Isolated output DC characteristics	24
Table 22 – Isolated output AC characteristics.....	24
Table 23 – Absolute maximum electrical ratings	32
Table 24 – Absolute maximum ratings for GPIO	32

2 Revision history

Version	Date	Notes
1.0	05/2020	Initial release
1.1	07/2022	Updates to Figure 9, Figure 8, Figure 7, Table 15, Table 16
2.0	06/2024	Updates to Figures. Updates to Mechanical drawings. Added new Frame Grabbers: <ul style="list-style-type: none"> • Predator II Single CoaXPress M.2 • Komodo II Dual CoaXPress • Komodo II Quad CoaXPress MXM • Komodo II Quad CoaXPress PCIe104 • Komodo III Quad CoaXPress • Komodo III Octo CoaXPress • Chameleon II CoF Added “ CoaXPress Frame Grabbers Power Connector” section

Table 1 – Revision History

3 Introduction

3.1 Safety precautions

With your card in hand, please take the time to read through the precautions listed below to prevent preventable and unnecessary injuries and damage to you, other personnel, or property. Read these safety instructions carefully before your first use of the product, as these precautions contain safety instructions that must be observed. Be sure to follow this manual to prevent misuse of the product.



Caution! Read Carefully and do not disregard these instructions.

In the event of a failure, disconnect the power supply

Disconnect the power supply immediately and contact our sales personnel for repair. Continuing to use the product in this state may result in a fire or electric shock.

If an unpleasant smell or smoking occurs, disconnect the power supply.

Disconnect the power supply immediately! Continuing to use the product in this state may result in a fire or electric shock. After verifying that no smoking is observed, contact our sales personnel for repair.

Do not disassemble, repair or modify the product.

This may result in a fire or electric shock due to a circuit shortage or heat generation. Contact our sales personnel before inspection, modification, or repair.

Do not place the product on unstable surfaces.

Otherwise, it may drop or fall, resulting in injury to persons or the camera.

Do not use the product if dropped or damaged.

Otherwise, a fire or electric shock may occur.

Do not touch the product with metallic objects.

Otherwise, a fire or electric shock may occur.

Do not place the product in dusty or humid environments, nor where water may splash.

Otherwise, a fire or electric shock may occur.

Do not wet the product or touch it with wet hands.

Otherwise, the product may fail or it may cause a fire, smoking, or electric shock.

Do not touch the gold-plated sections of the connectors on the product.

Otherwise, the surface of the connector may be contaminated by sweat or skin oil, resulting in contact failure of a connector, malfunction, fire or electric shock due to static electricity discharge.

Do not use or place the product in the following locations.

- Unventilated areas such as closets or bookshelves.
- Near oils, smoke or steam.
- Next to heat sources.
- A closed (and not running) car where the temperature becomes high.
- Static electricity replete locations
- Near water or chemicals.

Otherwise, a fire, electric shock, accident or deformation may occur due to a short circuit or heat generation.

Do not place heavy objects on the product.

Otherwise, the product may be damaged.

Be sure to discharge static electricity from the body before touching any sensitive electronic components.

The electronic circuits in your computer and the circuits on the *Iron* camera and the *Predator II* board are sensitive to static electricity and surges. Improper handling may seriously damage the circuits. In addition, do not let your clothing come in contact with the circuit boards or components. Otherwise, the product may be damaged.

3.2 Disclaimer

KAYA Instruments will assume no responsibility for any damage that may ensue by the use of this product for any purpose other than intended, as previously stated. Without detracting from what was previously written, please be advised that the company will take no responsibility for any damages caused by:

- Earthquake, thunderstrike, natural disasters, a fire caused by use beyond our control, willful and/or accidental misuse and/or use under other abnormal and/or unreasonable conditions.
- Secondary damages caused by the use of this product or its unusable state (business interruption or others).
- Use of this product in any manner that contradicts this manual or malfunctions that may occur due to connection to other devices. Damage to this product that is out of our control or failure due to modification.
- Accidents and/or third parties that may be involved.

Additionally, **KAYA Instruments** assumes no responsibility or liability for:

- Erasure or corruption of data caused by the use of this product.
- Any consequences or other abnormalities following the use of this product.

Repairs to this product are carried out by replacing it on a chargeable basis and not by repairing the faulty device. Non-chargeable replacement is offered for the initial failure, as long as it is reported no later than two weeks post delivery of the product.

4 Document Scope

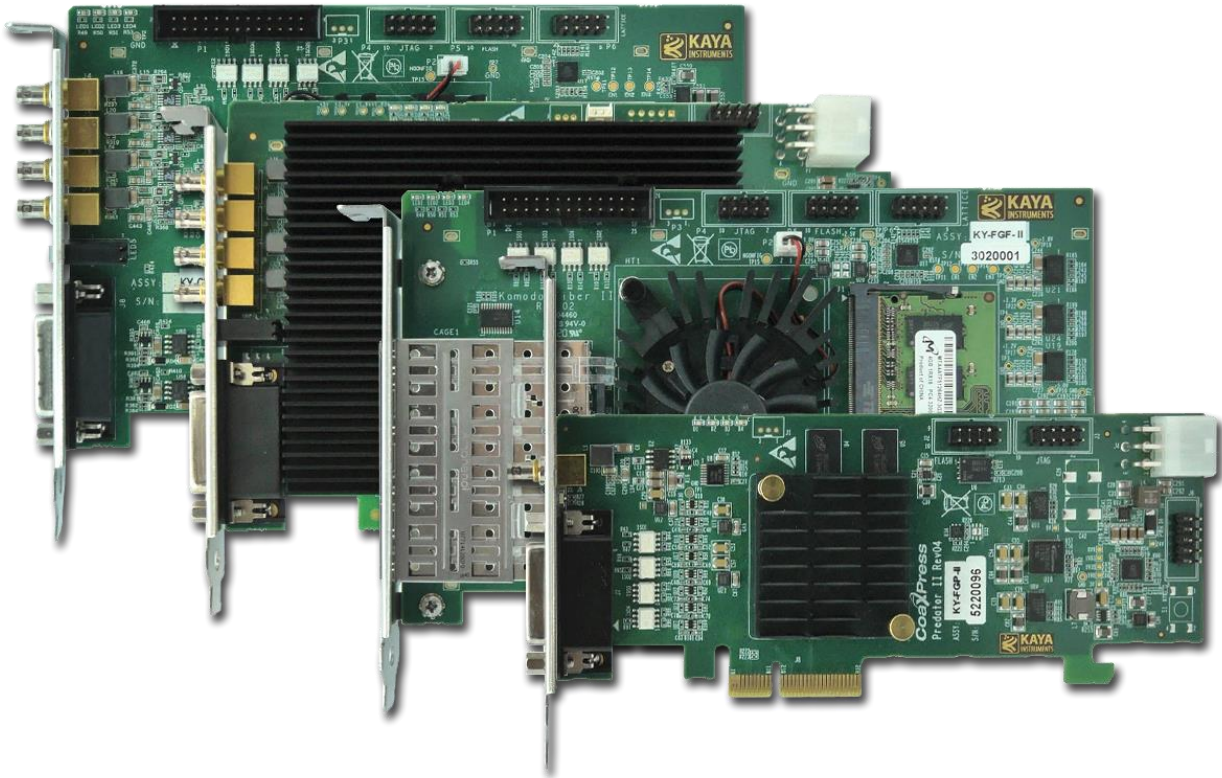

This document is meant to serve as a hardware reference and installation guide for KAYA's second- and third-generation frame grabbers: the Predator II Single CoaXPress, Predator II Single CoaXPress M.2, Predator II Single CoF, Predator II Single CLHS compatible, Komodo II Dual CoaXPress, Komodo II Quad CoaXPress, Komodo II Dual CLHS compatible, Komodo II Quad CLHS compatible, Komodo II Quad CoF, Komodo II Quad CoaXPress MXM, Komodo II Quad CoaXPress PCIe104, Chameleon II CoaXPress and Chameleon II CoF.

The guide consists of 8 chapters split into two main parts: the first (chapters 5 through 11) refers to the hardware of the cards and includes an overview and interface layouts, PCIe working modes, LED states, GPIO connectors and pinout, mechanical drawings, environmental conditions and electrical specifications. The second part refers to the installation and set-up process for each of the cards.

Please feel free to contact our team over at support@kayainstruments.com with any questions that may arise.

5 Cards Overview

5.1 Predator II Single CoaXPress connectors and LEDs Layout

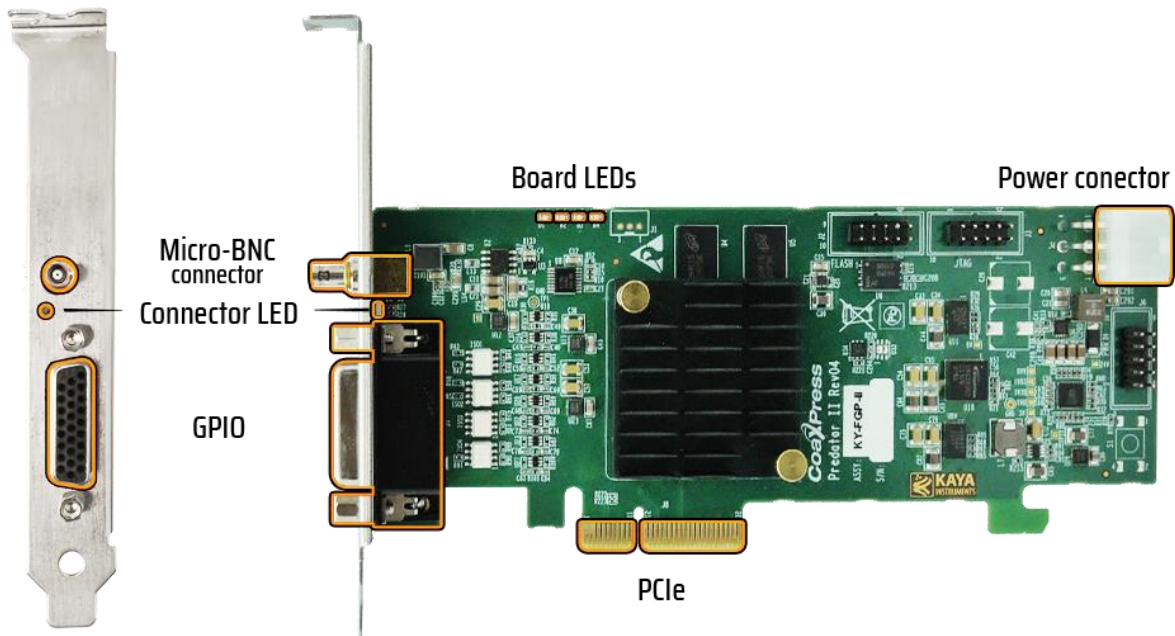

Figure 1 – Predator II Single CoaXPress connector topology

5.2 Predator II Single CoaXPress M.2 connectors and LEDs Layout

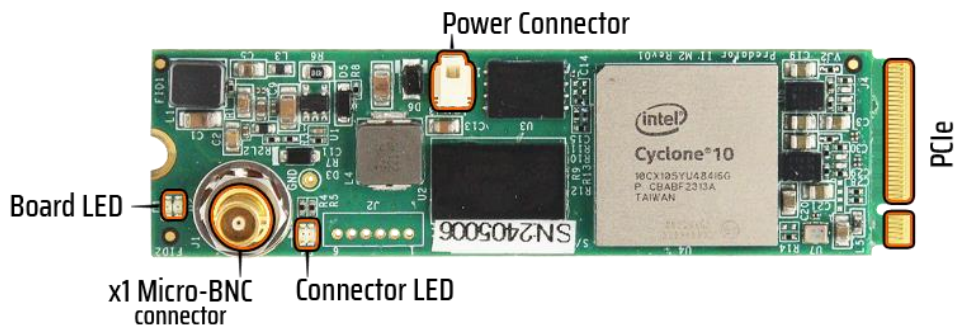

Figure 2 – Predator II Single CoaXPress M.2 connector topology

5.3 Predator II Single CoF / Predator II Single CLHS compatible connectors and LEDs Layout

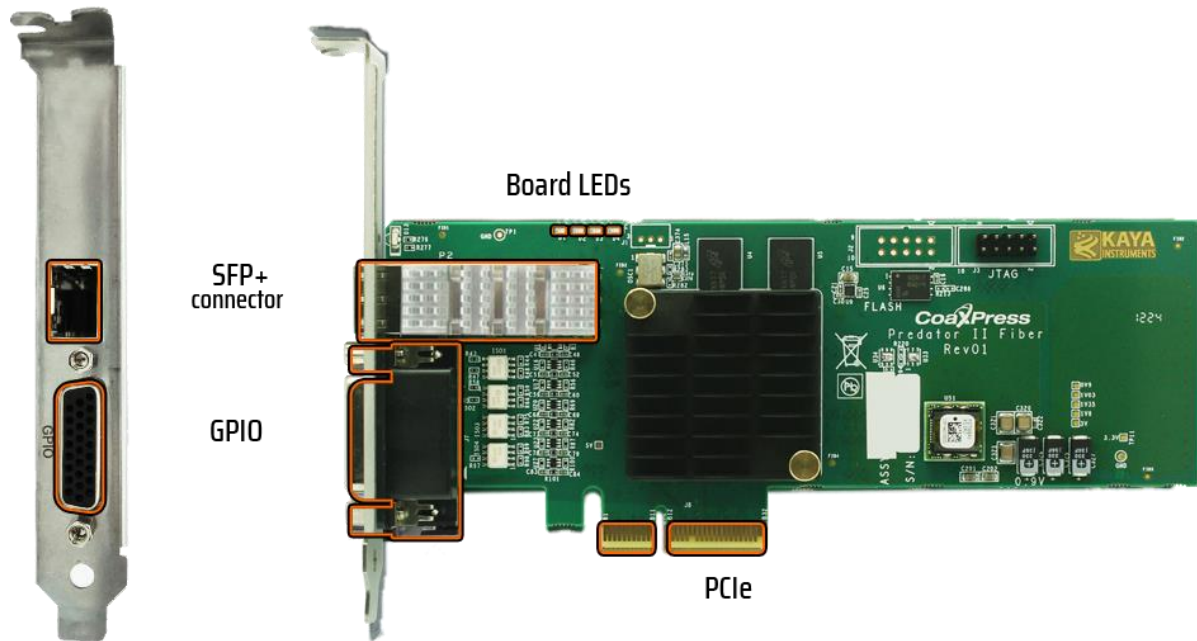

Figure 3 – Predator II Single CoF / Predator II Single CLHS compatible connector topology

5.4 Komodo II Dual CoaXPress connectors and LEDs Layout

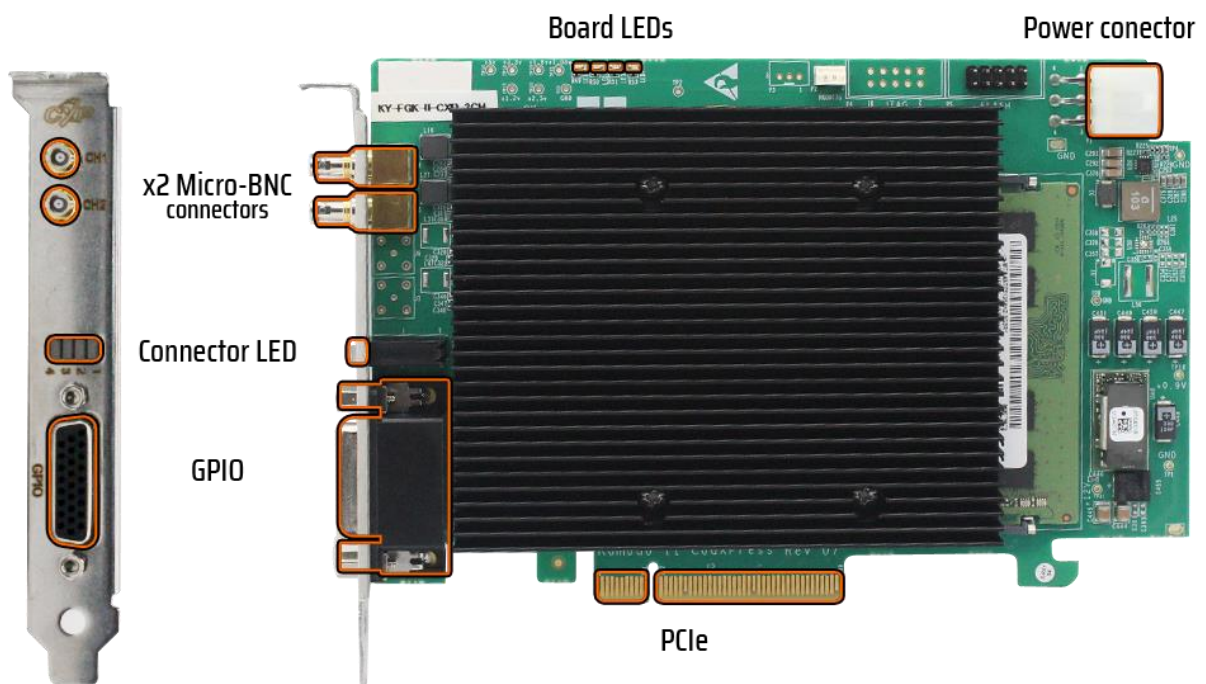

Figure 4 – Komodo II Dual CoaXPress connector topology

5.5 Komodo II Quad CoaXPress connectors and LEDs Layout

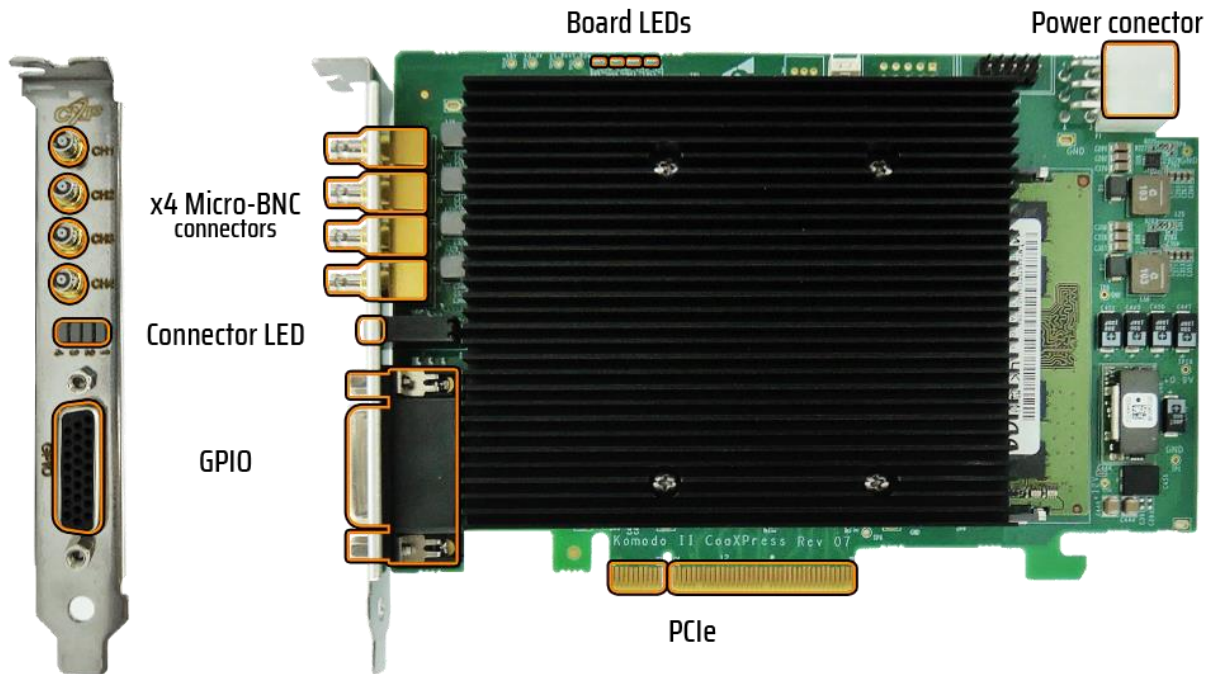

Figure 5 – Komodo II Quad CoaXPress connector topology

5.6 Komodo II Dual CLHS compatible connectors and LEDs Layout

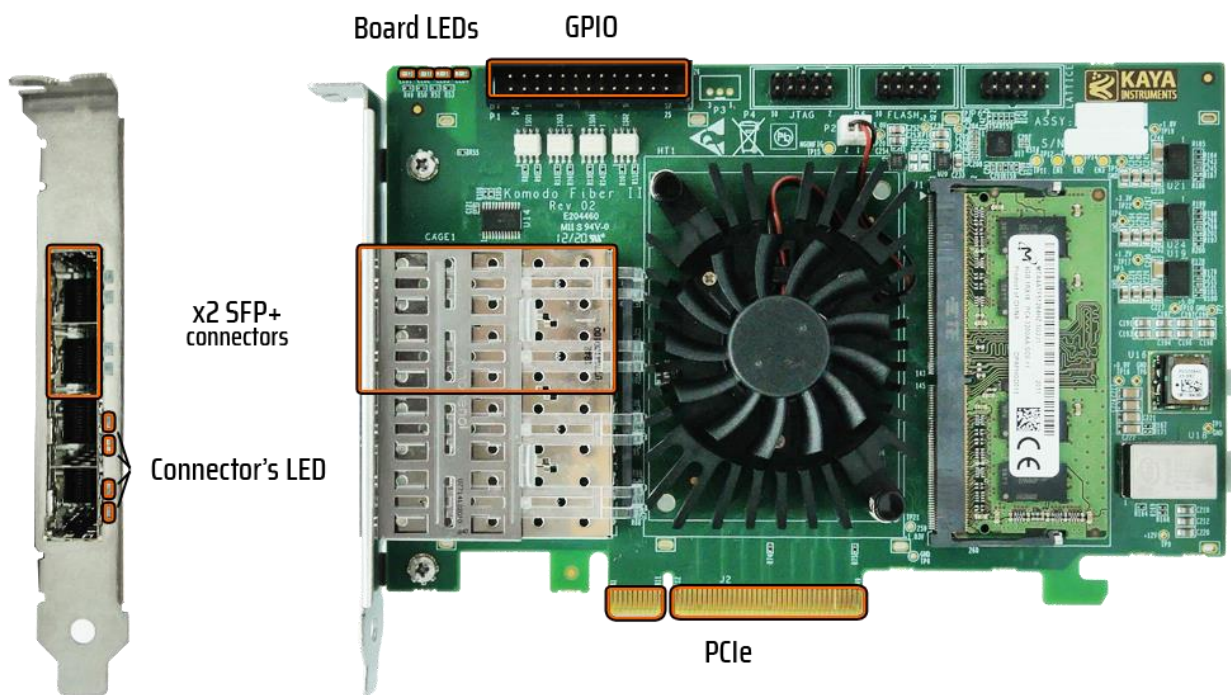

Figure 6 – Komodo II Dual CLHS compatible connector topology

5.7 Komodo II Quad CoF / Komodo II Quad CLHS compatible connectors and LEDs Layout

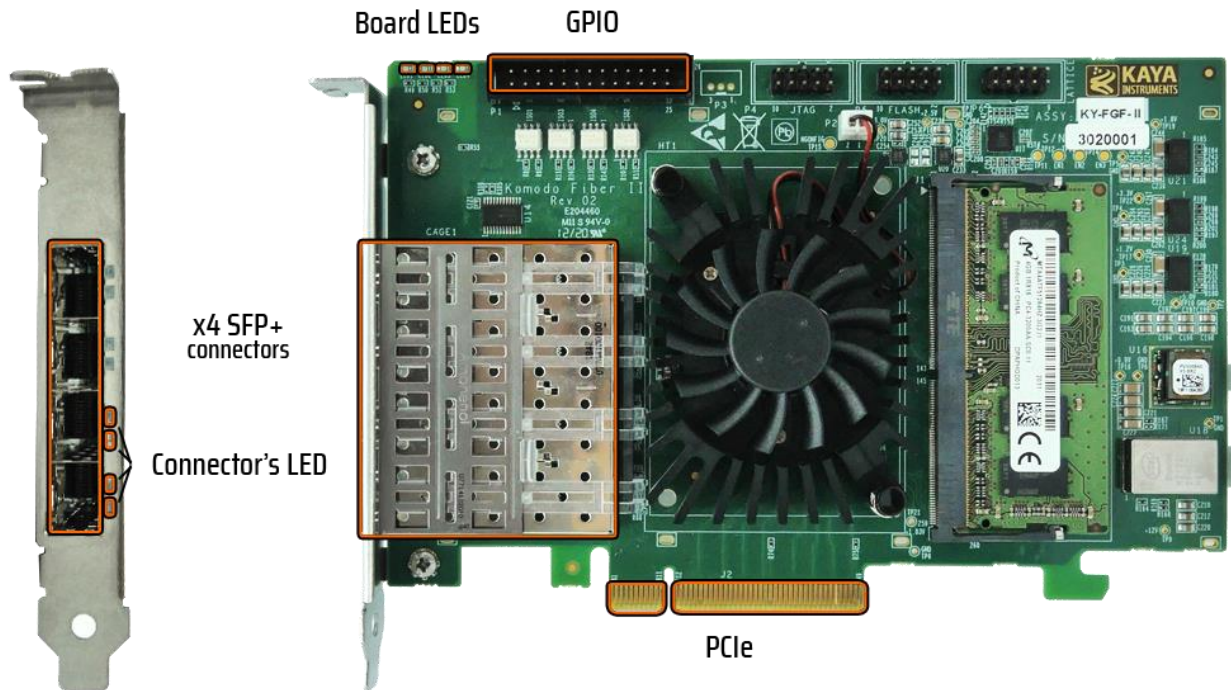

Figure 7 – Komodo II Quad CLHS compatible / Komodo II Quad CoF connector topology

5.8 Komodo II Quad CoaXPRESS MXM connectors and LEDs Layout

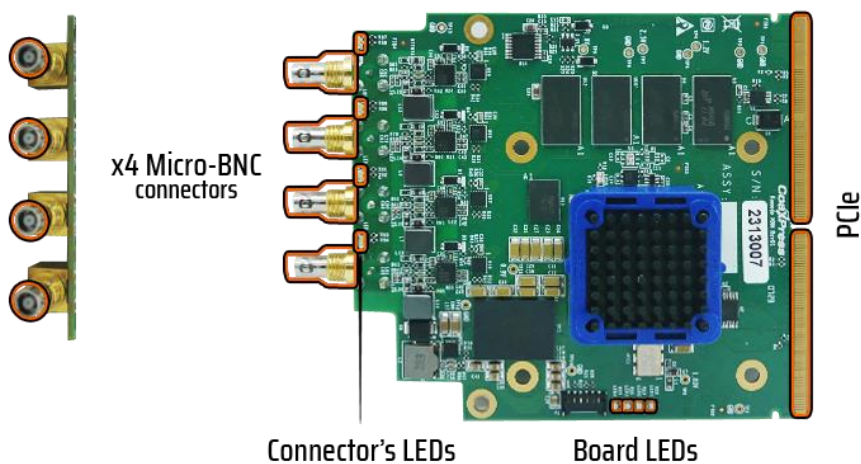

Figure 8 – Komodo II Quad CoaXPRESS MXM connector topology

5.9 Komodo II Quad CoaXPress PCIe104 connectors and LEDs Layout

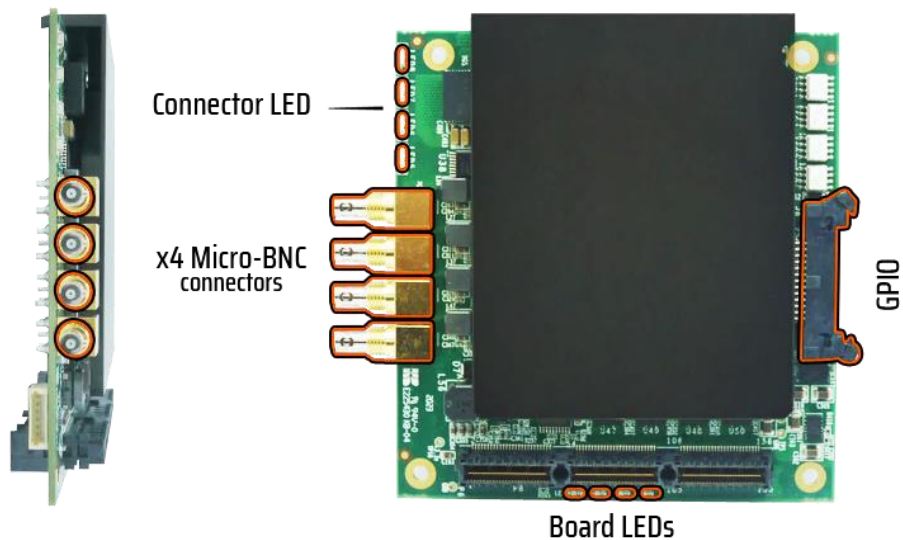

Figure 9 – Komodo II Quad CoaXPress PCIe104 connector topology

5.10 Komodo III Dual CoaXPress connectors and LEDs Layout

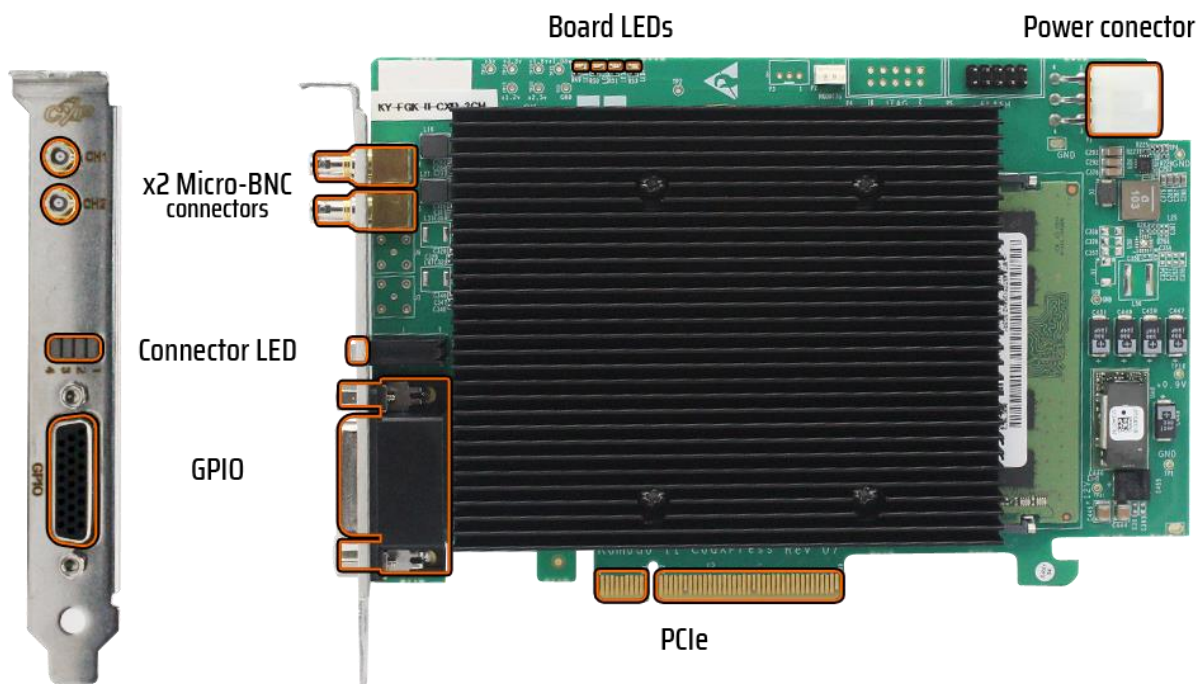

Figure 10 – Komodo II Dual CoaXPress connector topology

5.11 Komodo III Quad CoaXPress connectors and LEDs Layout

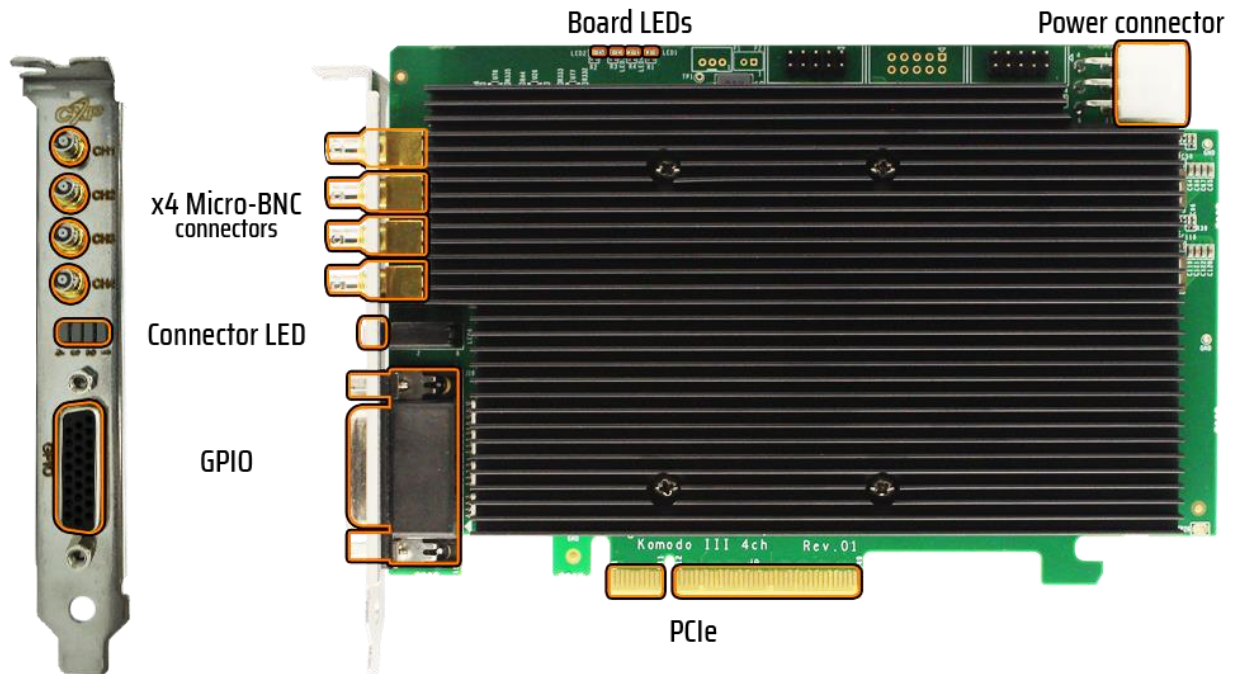

Figure 11 – Komodo II Quad CoaXPress connector topology

5.12 Komodo III Octo CoaXPress connectors and LEDs Layout

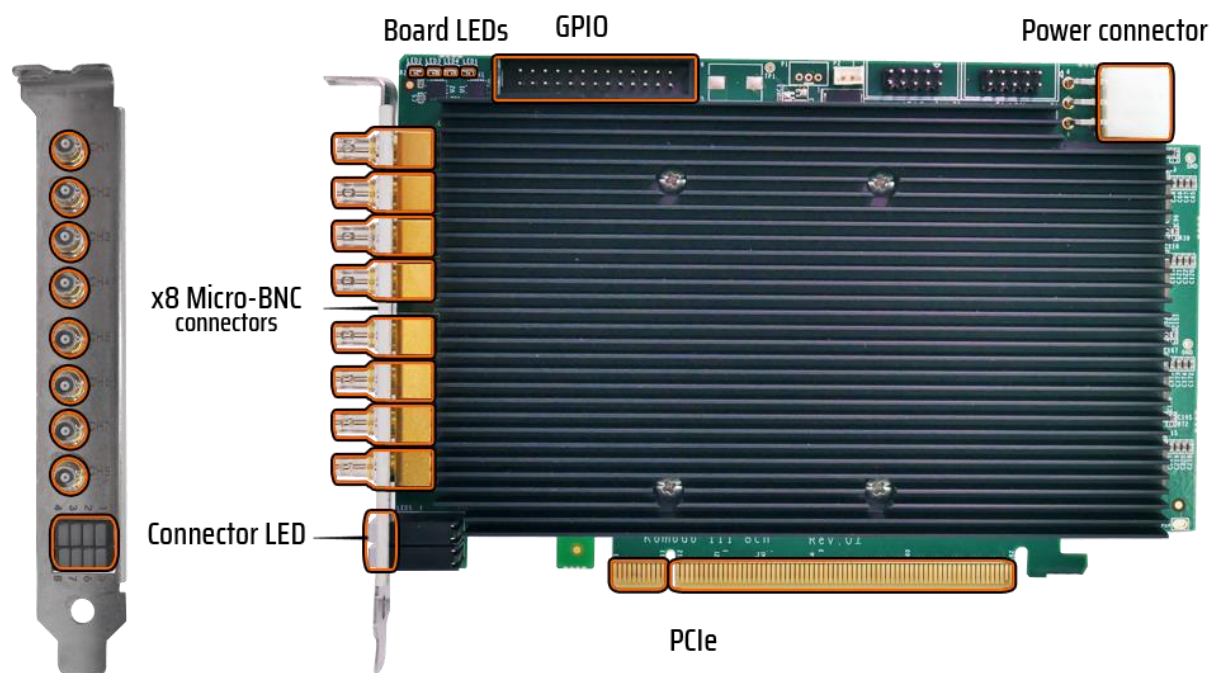

Figure 12 – Komodo II Octo CoaXPress connector topology

5.13 Chameleon II CoaXPress connectors and LEDs Layout

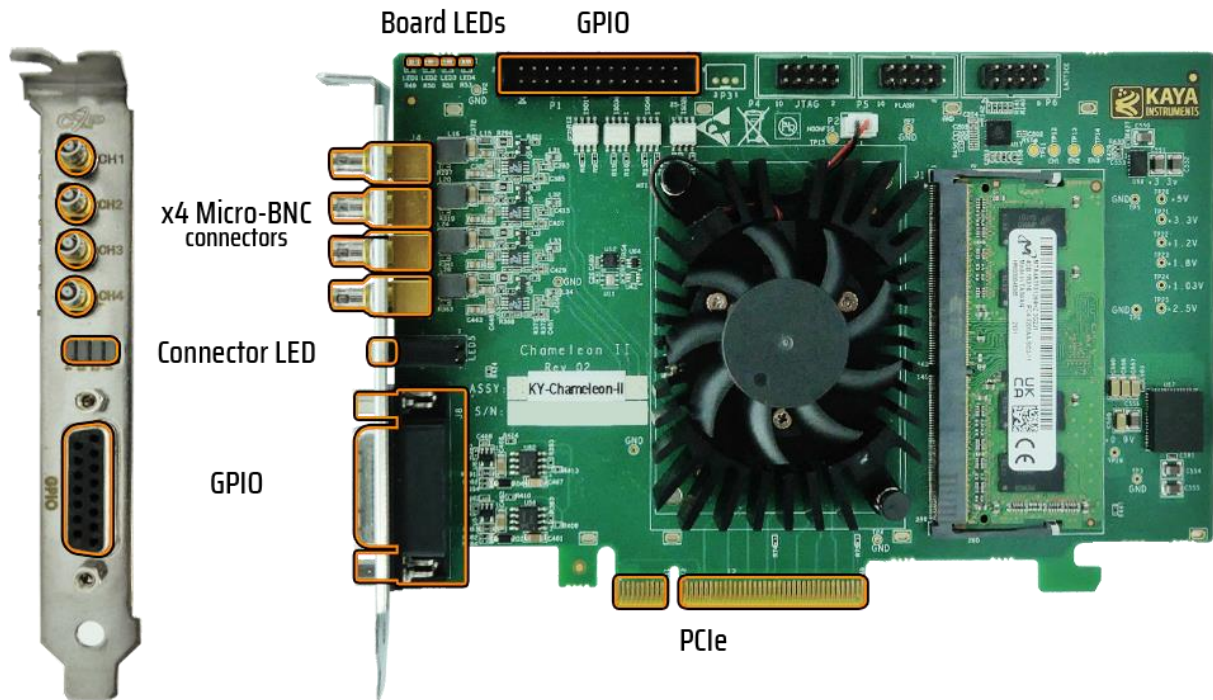

Figure 13 – Chameleon II CoaXPress connector topology

5.14 Chameleon II CoF connectors and LEDs Layout

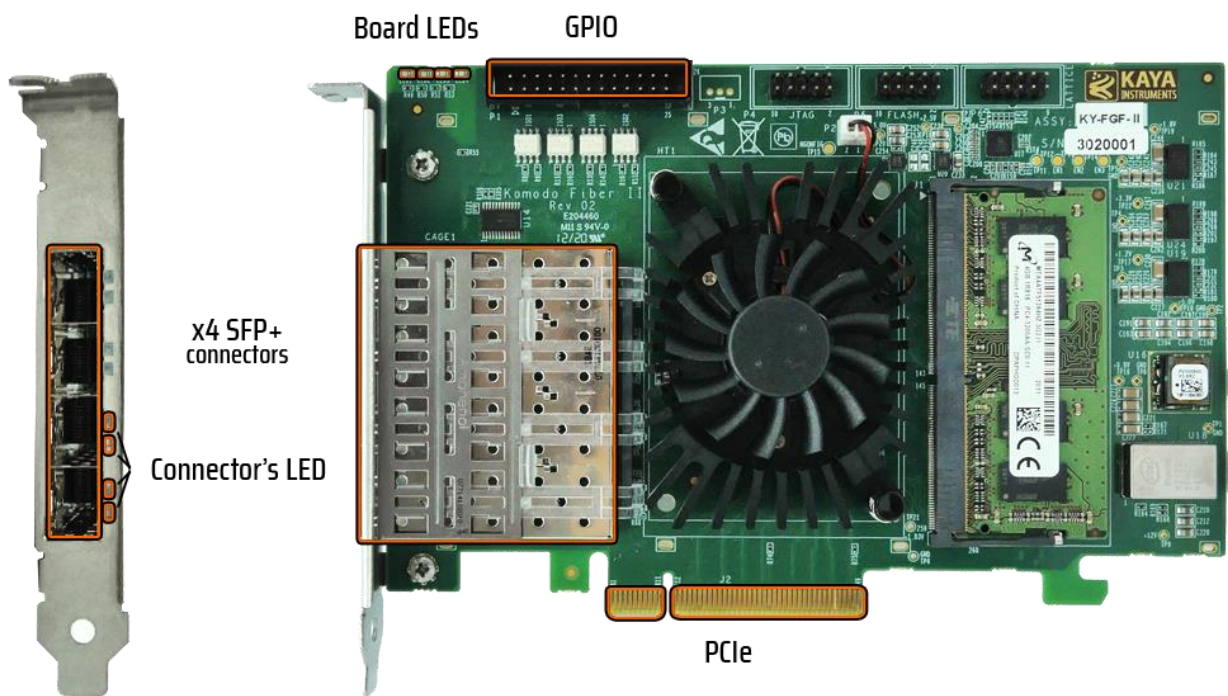

Figure 14 – Chameleon II CoF connector topology

6 PCIe Working Modes

The newest PCIe generations supported and maximal bandwidth for each card are listed in the following table:

Card	Newest Supported PCIe Generation	Maximal Bandwidth (Newest PCIe Generation)
Predator II Single CoaXPress	Gen 2.4, up to 4 lanes	12 [Gbps]
Predator II Single CoaXPress M.2	Gen 2.0, up to 2 lanes	6 [Gbps]
Predator II Single CoF	Gen 2.4, up to 4 lanes	12 [Gbps]
Predator II Single CLHS compatible	Gen 2.4, up to 4 lanes	12 [Gbps]
Komodo II Dual CoaXPress	Gen 3, up to 8 lanes	55 [Gbps]
Komodo II Quad CoaXPress	Gen 3, up to 8 lanes	55 [Gbps]
Komodo II Dual CLHS compatible	Gen 3, up to 8 lanes	55 [Gbps]
Komodo II Quad CLHS compatible	Gen 3, up to 8 lanes	55 [Gbps]
Komodo II Quad CoF	Gen 3, up to 8 lanes	55 [Gbps]
Komodo II Quad CoaXPress MXM	Gen 3, up to 8 lanes	55 [Gbps]
Komodo II Quad CoaXPress PCIe104	Gen 3, up to 8 lanes	55 [Gbps]
Komodo III Dual CoaXPress	Gen 3, up to 8 lanes	55 [Gbps]
Komodo III Quad CoaXPress	Gen 3, up to 8 lanes	55 [Gbps]
Komodo III Octo CoaXPress	Gen 3, up to 16 lanes	110 [Gbps]
Chameleon II CoaXPress	Gen 3, up to 8 lanes	40 [Gbps]
Chameleon II CoF	Gen 3, up to 8 lanes	55 [Gbps]

Table 2 – PCIe working modes

7 Card LEDs

7.1.1 Connector LEDs

The bi-color LEDs behave according to the definition in section 5.4 of the CoaXPress standard. Color-coded indications along with the exact timing for each indicator are shown in the following tables:









LED state	Indication
	Solid green The camera is connected, and no data is being transferred
	Fast flash green The camera is connected, and data is being transferred
	Fast flash alternate green/orange Connection detection in progress, PoCXP active
	Slow flash alternate green/orange Connection test packets being sent
	Solid orange The system is not initialized
	Slow pulse orange Camera connected. Waiting for the trigger event
	Fast flash orange Connection detection in progress, PoCXP not in use
	Slow pulse red No camera is connected
	Solid red PoCXP over-current

Table 3 – Connector indicator lamp states



Indication	Timing
	Fast flash 12.5 Hz (20 ms on, 60 ms off)
	Slow flash 0.5 Hz (1 s on, 1 s off)
	Slow pulse 1 Hz (200 ms on, 800 ms off)

Table 4 – Connector indication lamp timings

7.1.2 Board Status LEDs

LED	Description
0	Alive led. Blinks when the board receives clock from PCIe
1	PCIe L0 state. When lit, indicates that the PCIe interface is powered up at an active state.
2	Maximum supported PCIe gen indicator. When lit indicates that PCIe is working as Gen3 (2.4 for the Predator II CoaXPress) When not lit the board works either as PCIe Gen1 or Gen2 (or just PCIe Gen1 for the Predator II CoaXPress).
3	Lane's indicator. When lit, indicates that all PCIe lanes are up. If not lit, one of four lanes is up (only one for the Predator II CoaXPress).

Table 5 – Status indicator lamp states

8 CoaXPress Cables

CoaXPress is a new digital transmission standard that allows high-speed data from a device, such as a camera, to be transferred to a host, such as a frame grabber. Each CoaXPress link supports up to 12.5 Gbps data rates, along with device power up to 13 W and device control at up to 41.6 Mbps – all on a single coax cable. For very fast devices, the links can be aggregated to provide multiples of the single coax bandwidth. Long cable lengths are supported – up to 30 meters at 12.5 Gbps and over 100 meters at 3.125 Gbps.

Table 6 gives an overview of typical link performance at room temperature for the link between two FMX II CoaXPress boards, using the downlink channel, uplink channel and power transmission simultaneously.



BELDEN		Name	Belden 7731A	Belden 1694A	Belden 1505A	Belden 1505F	Belden 1855A
		Type	Long Distance	Industry Standard	Compromise Coax	Flexible	Thinnest cable
Diameter	(mm)		10.3	6.99	5.94	6.15	4.03
1.25 Gbps	(m)		194	130	107	80	55
2.5 Gbps	(m)		162	110	94	66	55
3.125 Gbps	(m)		147	100	86	60	55
5.0 Gbps	(m)		87	60	52	35	38
6.25 Gbps	(m)		58	40	35	23	25
10 Gbps	(m)		TBD	40	TBD	TBD	TBD
12 Gbps	(m)		TBD	30	TBD	TBD	TBD
		Length					

GEPKO		Name	Gepco VHD1100	Gepco VSD2001	Gepco VPM2000	Gepco VHD2000M	Gepco VDM230
		Type	Long Distance	Industry Standard	Compromise Coax	Flexible	Thinnest cable
Diameter	(mm)		10.3	6.91	6.15	6.15	4.16
1.25 Gbps	(m)		212	140	109	81	66
2.5 Gbps	(m)		185	120	94	67	66
3.125 Gbps	(m)		169	110	86	61	62
5.0 Gbps	(m)		102	66	53	36	38
6.25 Gbps	(m)		68	44	35	24	25
10 Gbps	(m)		TBD	TBD	TBD	TBD	TBD
12 Gbps	(m)		TBD	TBD	TBD	TBD	TBD
		Length					

Table 6 – Typical link performance

9 Power Connector

9.1 CoaXPress Frame Grabbers Power Connector

Our CoaXPress cards (**Predator II CoaXPress**, **Komodo II CoaXPress**, **Komodo III CoaXPress** and **Chameleon II CoaXPress**) use standard power connectors.

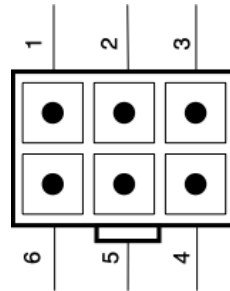

Figure 15 – 6-pin power connector

The signals for each pin are shown in the following table:

pin	1	2	3	4	5	6
signal		12 V input			GND	

Table 7 – 6-pin Power connector pinout

The **Predator II Single CoaXPress M.2** uses 2-pin PoCXP power connector.

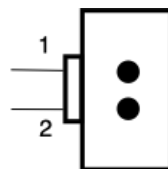

Figure 16 – 2-pin power connector

The signals for each pin are shown in the following table:

pin	1	2
signal	GND	12 V input

Table 8 – 2-pin Power connector pinout

10 General Purpose Input Output

10.1 GPIO Connectors

Our second- and third-generation cards come with one of two possible GPIO connectors: the 26-pin, 3-row D-Sub connector accessible from the front bracket (Predator II CoaXPress, Predator II CoF, Predator II CLHS compatible, Komodo II CoaXPress, Komodo III CoaXPress and Chameleon II CoaXPress) and the 26-pin, dual row pin header connector that is located on the PCB itself (Komodo II CLHS compatible and Chameleon II CoaXPress).

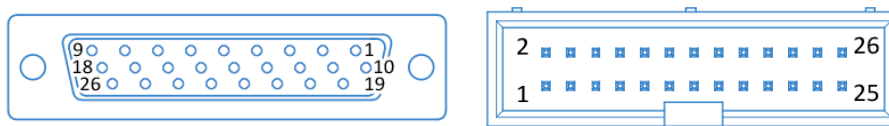

Figure 17 – GPIO connector schematics
 3-row D-Sub connector (left) and dual row pin header (right)

Connector	Manufacturer's Part Number
26-pin, 3-row D-Sub	181-026-213R561
26-pin, dual row pin header	CH87262V200

Table 9 – GPIO connectors part numbers

10.2 GPIO Pinout

The pinout for each of these connectors is as described:

Pin	Signal Name	Function	Electrical Standard	Description
1	LVDS Input 0p	LVDS input	LVDS	Positive signal of LVDS pair
2	LVDS Input 0n	LVDS input	LVDS	Positive signal of LVDS pair
3	LVDS Input 1p	LVDS input	LVDS	Negative signal of LVDS pair
4	LVDS Input 1n	LVDS input	LVDS	Negative signal of LVDS pair
5	LVDS Output 0p	LVDS output	LVDS	Positive signal of LVDS pair
6	LVDS Output 0n	LVDS output	LVDS	Positive signal of LVDS pair
7	LVDS Output 1p	LVDS output	LVDS	Negative signal of LVDS pair
8	LVDS Output 1n	LVDS output	LVDS	Negative signal of LVDS pair
9	Optocoupled Output 0	Opto-Isolated output	Up to 70 V	Optically isolated outputs
10	Optocoupled Output 1	Opto-Isolated output	Up to 70 V	Optically isolated outputs
11	Optocoupled Output 2	Opto-Isolated output	Up to 70 V	Optically isolated outputs
12	Optocoupled Output 3	Opto-Isolated output	Up to 70 V	Optically isolated outputs
13	Optocoupled Input 0	Opto-Isolated input	Up to 70 V	Optically isolated inputs
14	Optocoupled Input 1	Opto-Isolated input	Up to 70 V	Optically isolated inputs
15	Optocoupled Input 2	Opto-Isolated input	Up to 70 V	Optically isolated inputs
16	Optocoupled Input 3	Opto-Isolated input	Up to 70 V	Optically isolated inputs
17	Optocoupled GND	External GND		Ground signal for optoisolated signals on this connector
18	GND	Board GND		Reference ground signal
19	TTL 0	GPIO	TTL (Open-drain)	General Purpose IO
20	TTL 1	GPIO	TTL (Open-drain)	General Purpose IO
21	TTL 2	GPIO	TTL (Open-drain)	General Purpose IO
22	TTL 3	GPIO	TTL (Open-drain)	General Purpose IO
23	LVTTTL 0	GPIO	LVTTTL	General Purpose IO
24	LVTTTL 1	GPIO	LVTTTL	General Purpose IO
25	LVTTTL 2	GPIO	LVTTTL	General Purpose IO
26	LVTTTL 3	GPIO	LVTTTL	General Purpose IO

Table 10 – GPIO connector pinout

10.3 GPIO Output / Input

10.3.1 LVDS Inputs

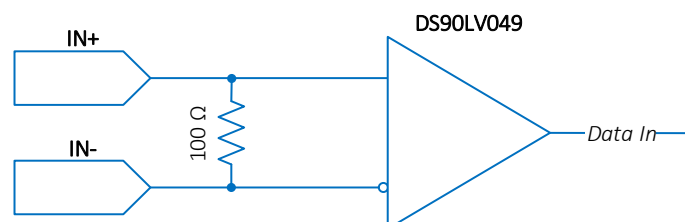

Figure 18 – LVDS inputs schematics

DC Characteristics:

Parameter	Conditions	Min	Typical	Max	Units
Common mode voltage		0.05		3	V
Differential sensitivity				100	mV
Input impedance			100		Ohm
ESD protection	HBM, 1.5 k Ω , 100 pF	7			kV
	MM, 0 Ω , 200 pF	250			V

Table 11 – LVDS inputs DC characteristics

AC Characteristics:

Parameter	Conditions	Min	Typical	Max	Units
Pulse width		50			ns
Pulse rate		0		5	MHz
10%-90% rise/fall time		0.3		1.4	ns

Table 12 – LVDS inputs DC & AC characteristics

10.3.2 LVDS Outputs

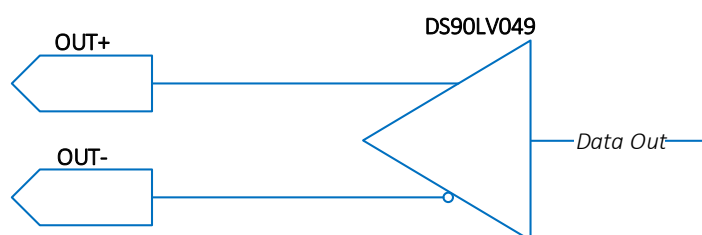

Figure 19 – LVDS outputs schematics

DC Characteristics:

Parameter	Conditions	Min	Typ	Max	Units
Common mode voltage		1.125	1.23	1.375	V
Differential output voltage		250	350	450	mV
Output Short Circuit Current			-5.8	-9	mA
ESD protection	HBM, 1.5 k Ω , 100 pF	7			kV
	MM, 0 Ω , 200 pF	250			V

Table 13 – LVDS outputs DC characteristics

AC Characteristics:

Parameter	Conditions	Min	Typ	Max	Units
Pulse width		50			ns
Pulse rate		0		5	MHz
10%-90% rise/fall time		0.2	0.4	1	ns

Table 14 – LVDS outputs AC characteristics

10.3.3 TTL Inputs/Outputs

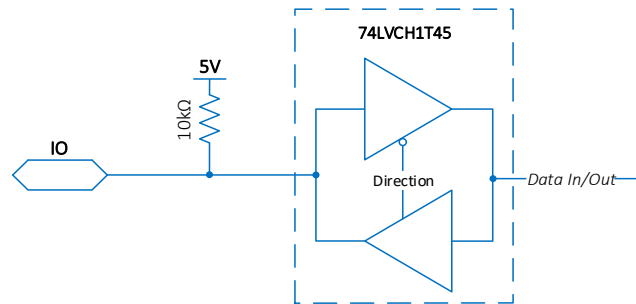

Figure 20 – TTL inputs/outputs schematics

DC Characteristics:

Parameter	Conditions	Min	Typical	Max	Units
Low-level output current				50	mA
Low-level output voltage	IO = 32 mA			0.55	V
High-level output current				-50	mA
High-level output voltage	IO = -32 mA	3.8			V
Low-level input voltage				1.5	V
High-level input voltage		3.5			V
Absolute maximum input		-0.5		6.5	V
ESD protection	HBM JESD22-A114F	4			kV
	CDM JESD22-C101E	1			kV

Table 15 – TTL inputs/outputs DC characteristics

AC Characteristics:

Parameter	Conditions	Min	Typical	Max	Units
Pulse width		50			ns
Pulse rate		0		5	MHz

Table 16 – TTL inputs/outputs AC characteristics

10.3.4 LVTTTL Inputs/Outputs

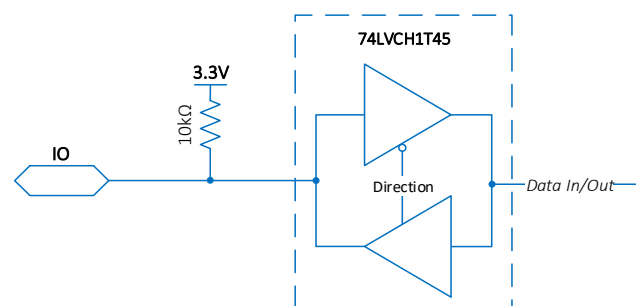

Figure 21 – LVTTTL inputs/outputs schematics

DC Characteristics:

Parameter	Conditions	Min	Typical	Max	Units
Low-level output current				50	mA
Low-level output voltage	IO = 24 mA			0.55	V
High-level output current				-50	mA
High-level output voltage	IO = -24 mA	2.4			V
Low-level input voltage				0.8	V
High-level input voltage		2.3			V
Absolute maximum input		-0.5		6.5	V
ESD protection	HBM JESD22-A114F	4			kV
	CDM JESD22-C101E	1			kV

Table 17 – LVTTTL inputs/outputs DC characteristics

AC Characteristics:

Parameter	Conditions	Min	Typical	Max	Units
Pulse width		50			ns
Pulse rate		0		5	MHz

Table 18 – LVTTTL inputs/outputs AC characteristics

10.3.5 Isolated Input

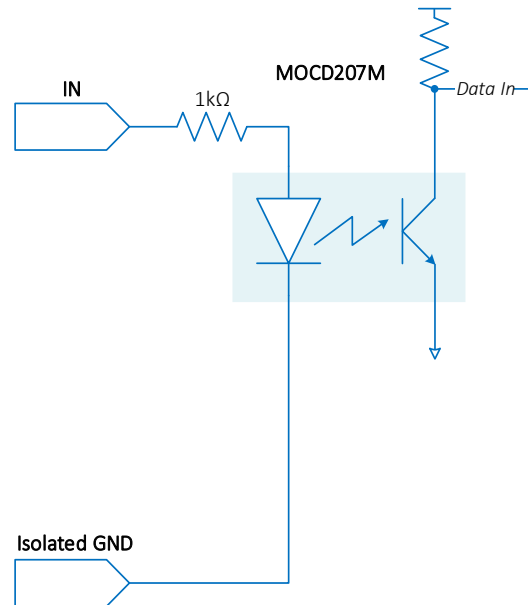

Figure 22 – Isolated input schematics

When the input current exceeds the threshold, the input logic state is HIGH.
 Opto isolater used is MOCD223R2M.

DC Characteristics:

Parameter	Conditions	Min	Typical	Max	Units
Input Voltage		-6		50	V
Input current threshold			3		mA
DC Isolation		250			V
AC Isolation		150			V _{RMS}

Table 19 – Isolated input DC characteristics

AC Characteristics:

Parameter	Conditions	Min	Typical	Max	Units
Pulse width		10			us
Pulse rate		0		5	KHz

Table 20 – Isolated input AC characteristics

10.3.6 Isolated Output

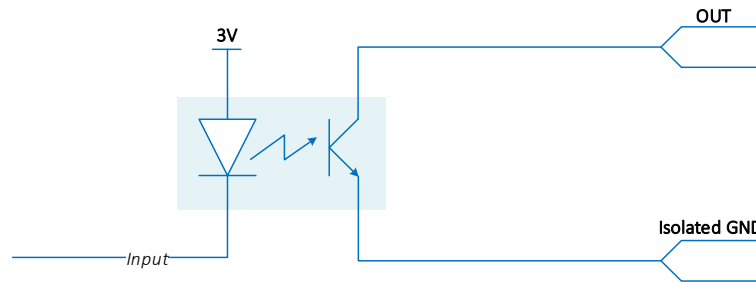

Figure 23 – Isolated output schematics

When the logic state is HIGH the output is in a conductive state (switch ON).
 Opto isolater used is MOCD223R2M.

DC Characteristics:

Parameter	Conditions	Min	Typical	Max	Units
Input Voltage		-6		50	V
Input current threshold				150	mA
DC Isolation		250			V
AC Isolation		150			V _{RMS}

Table 21 – Isolated output DC characteristics

AC Characteristics:

Parameter	Conditions	Min	Typical	Max	Units
Pulse width		10			us
Pulse rate		0		5	KHz

Table 22 – Isolated output AC characteristics

11 Mechanical Specifications

11.1 Mechanical Drawings

11.1.1 Predator II Single CoaXPress Mechanical Drawing

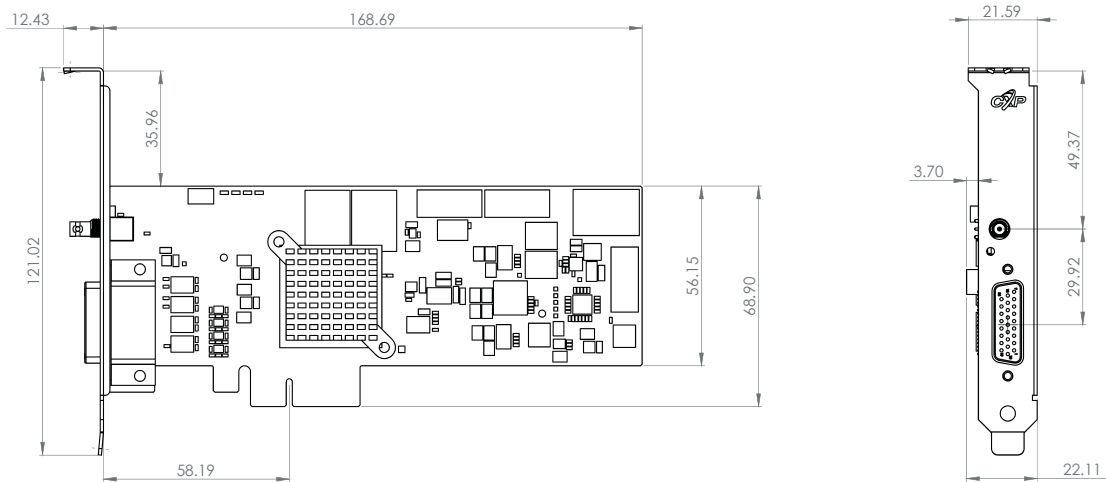

11.1.2 Predator II Single CoaXPress M.2 Mechanical Drawing

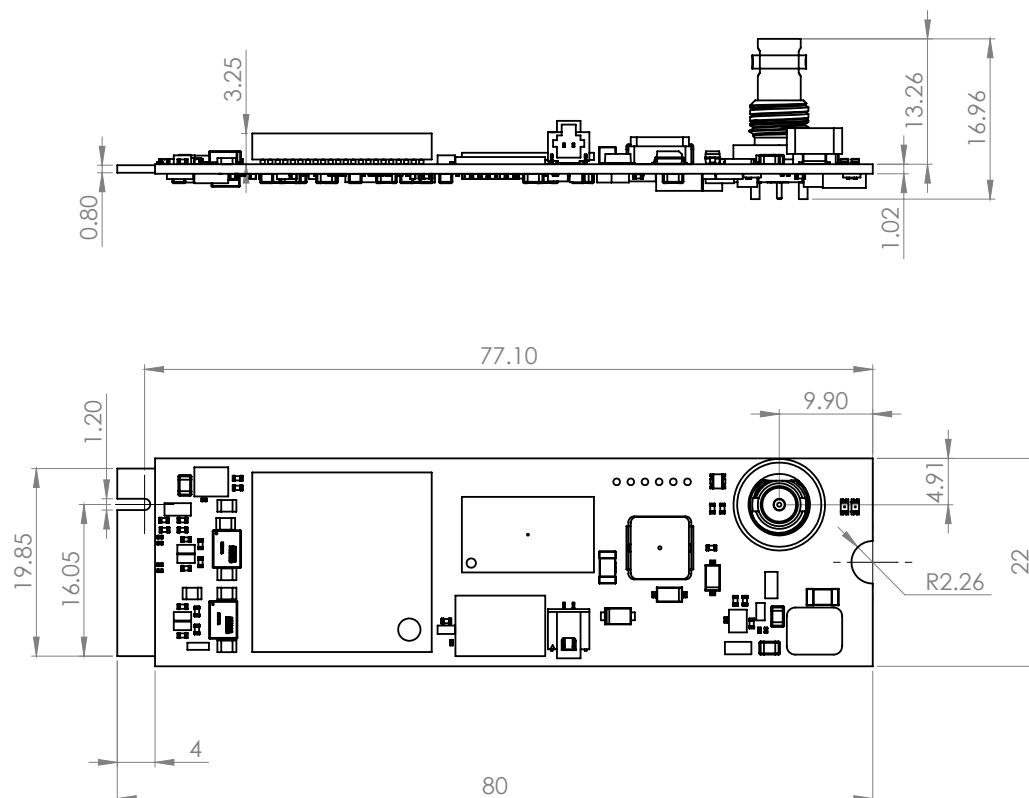

11.1.3 Predator II Single CoF / Predator II Single CLHS compatible Mechanical Drawing

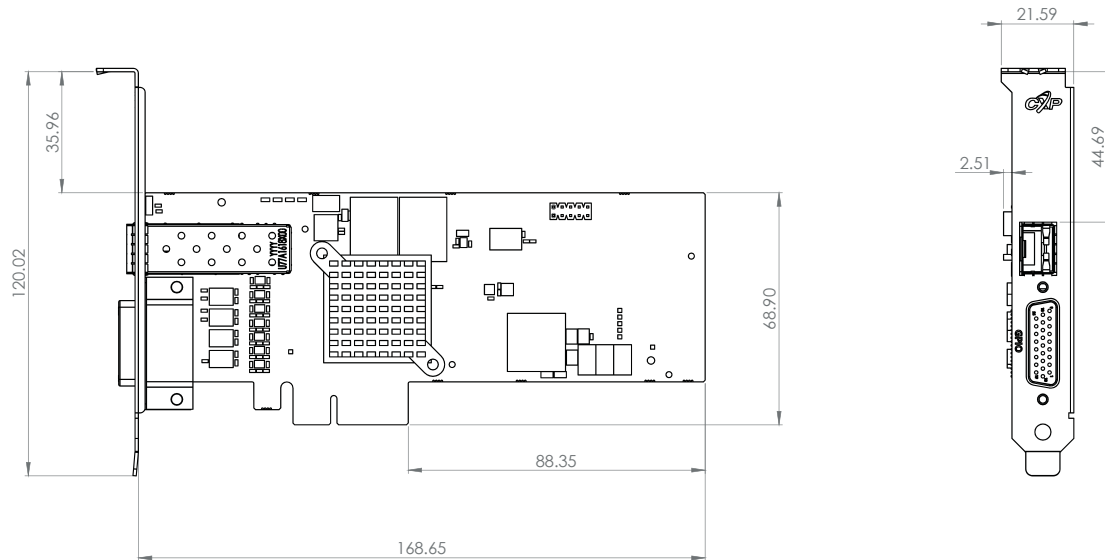

11.1.4 Komodo II Dual CoaXPress Mechanical Drawing

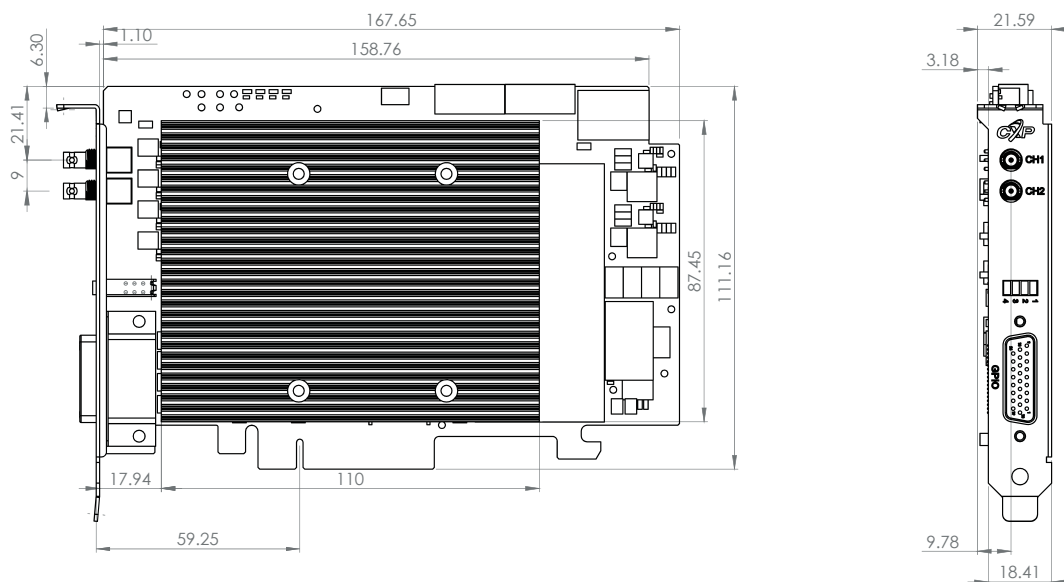

11.1.5 Komodo II Quad CoaXPress Mechanical Drawing

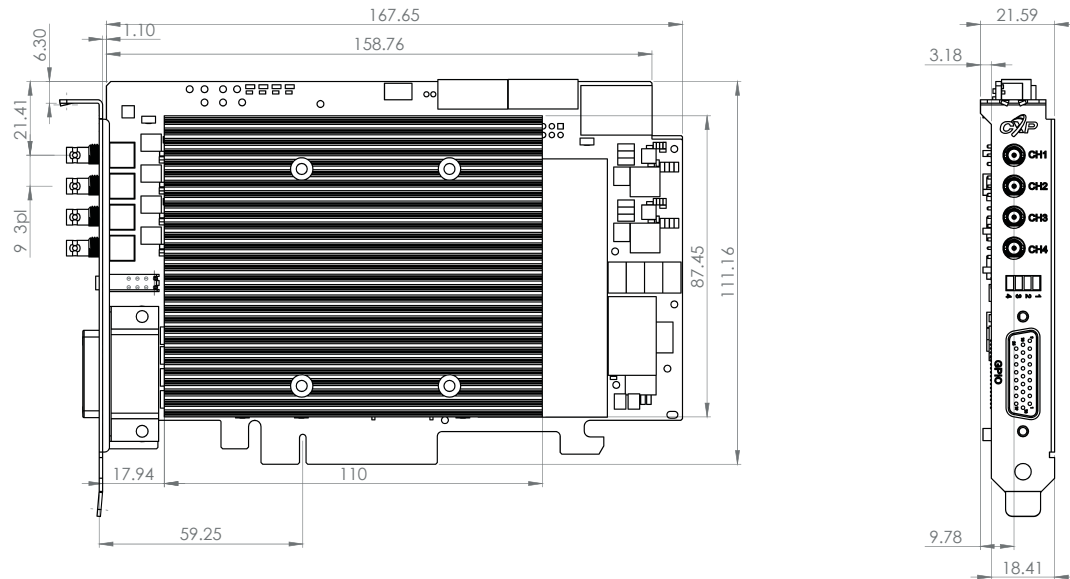

11.1.6 Komodo II Dual CLHS compatible Mechanical Drawing

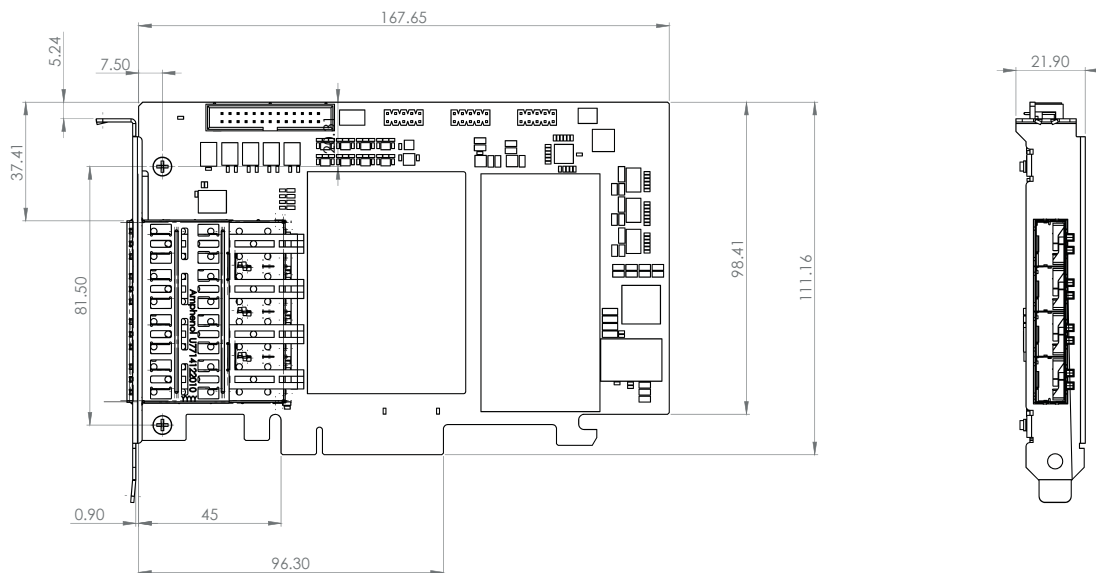

11.1.7 Komodo II Quad CoF / Komodo II Quad CLHS compatible Mechanical Drawing

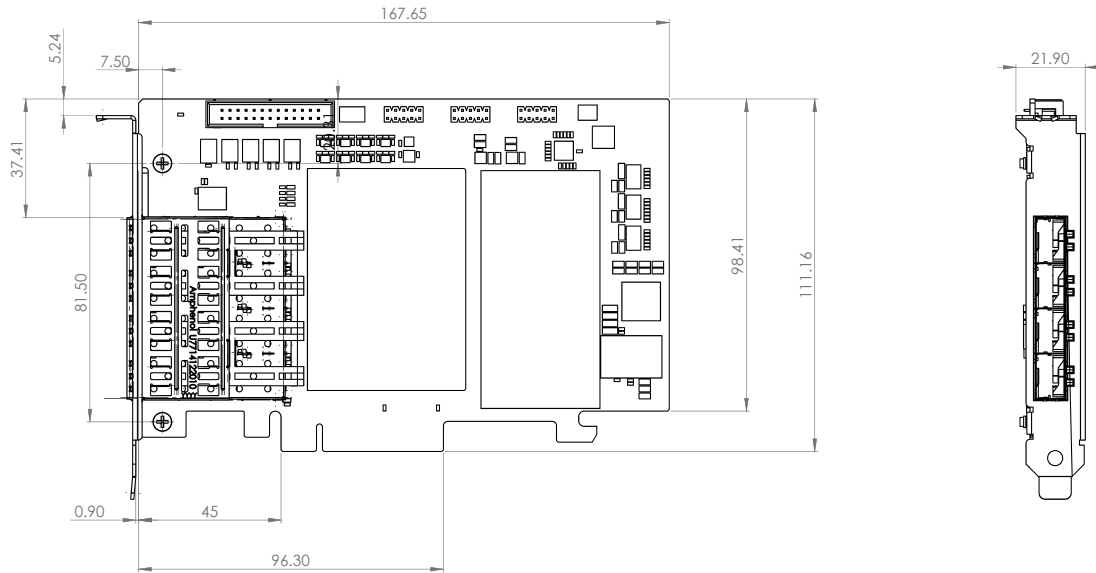

11.1.8 Komodo II Quad CoaXPress MXM Mechanical Drawing

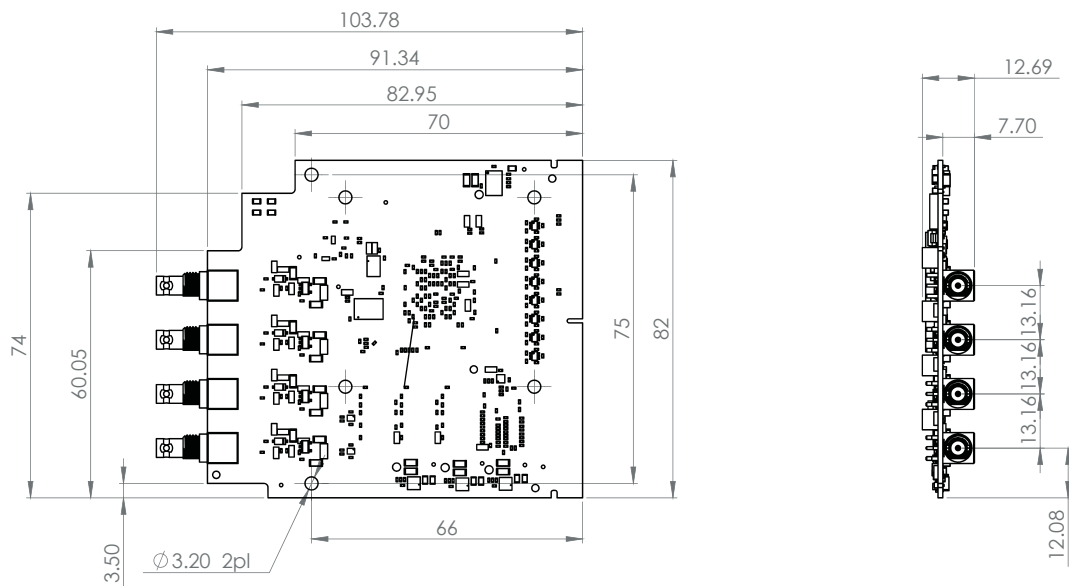

11.1.9 Komodo II Quad CoaXPress PCIe104 Mechanical Drawing

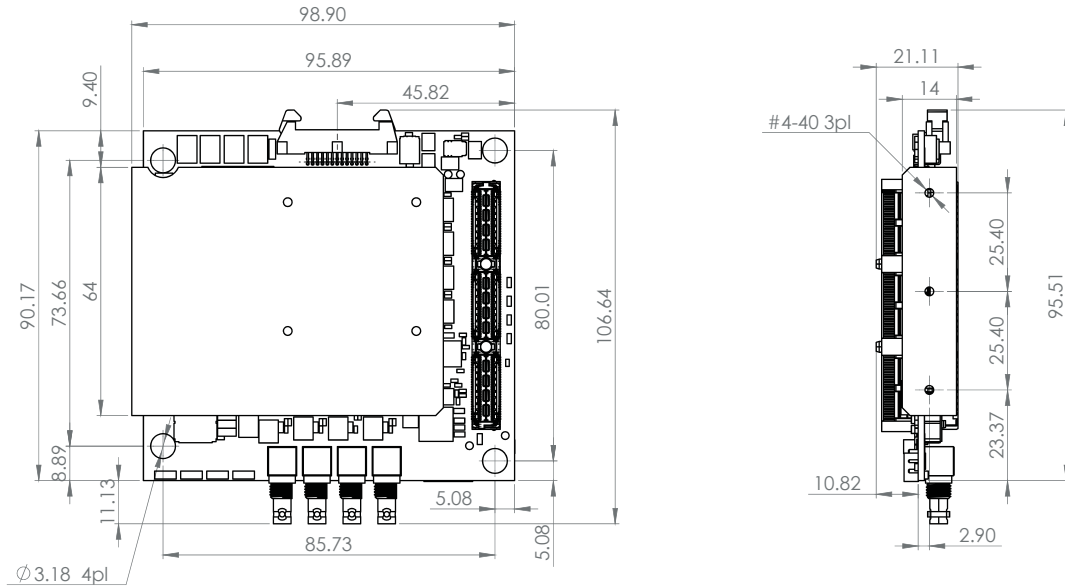

11.1.10 Komodo III Dual CoaXPress Mechanical Drawing

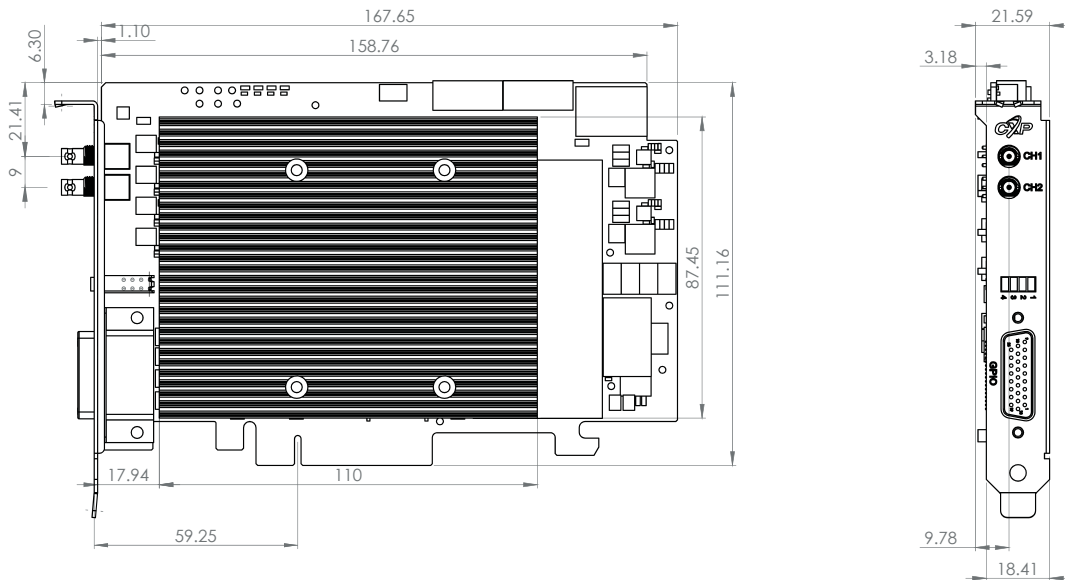

11.1.11 Komodo III Quad CoaXPress Mechanical Drawing

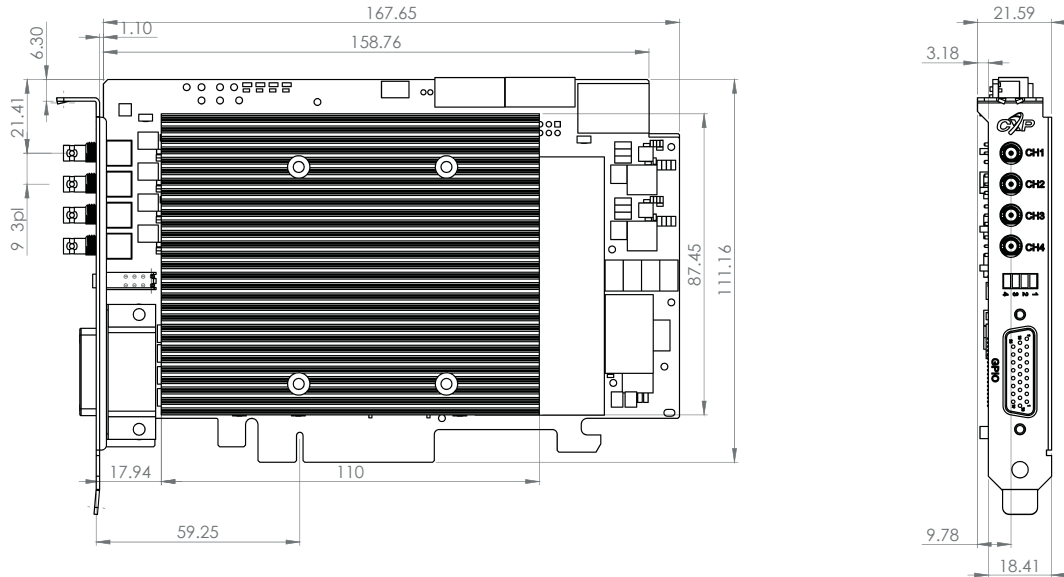

11.1.12 Komodo III Octo CoaXPress Mechanical Drawing

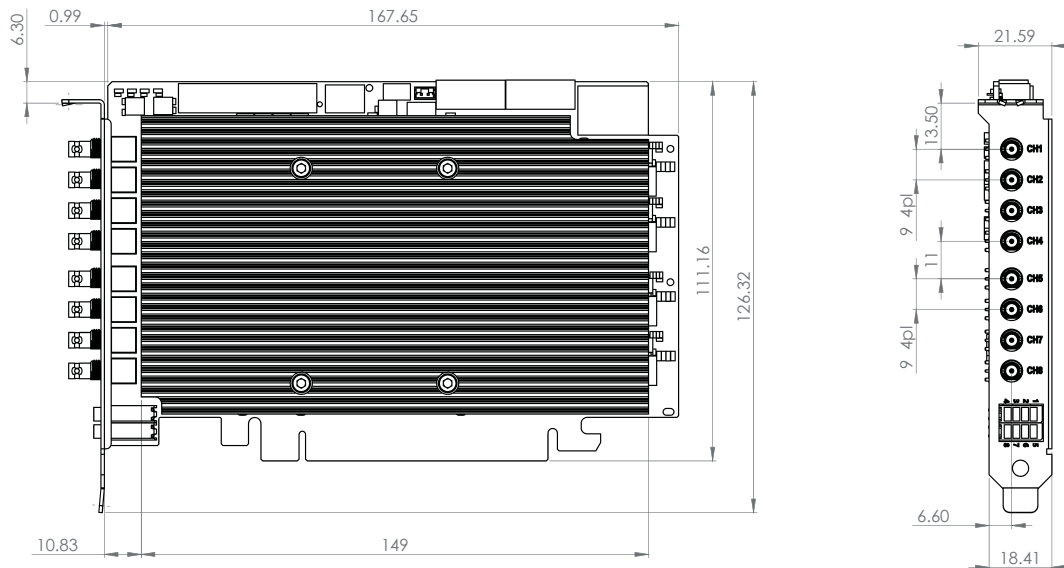

11.1.13 Chameleon II CoaXPress

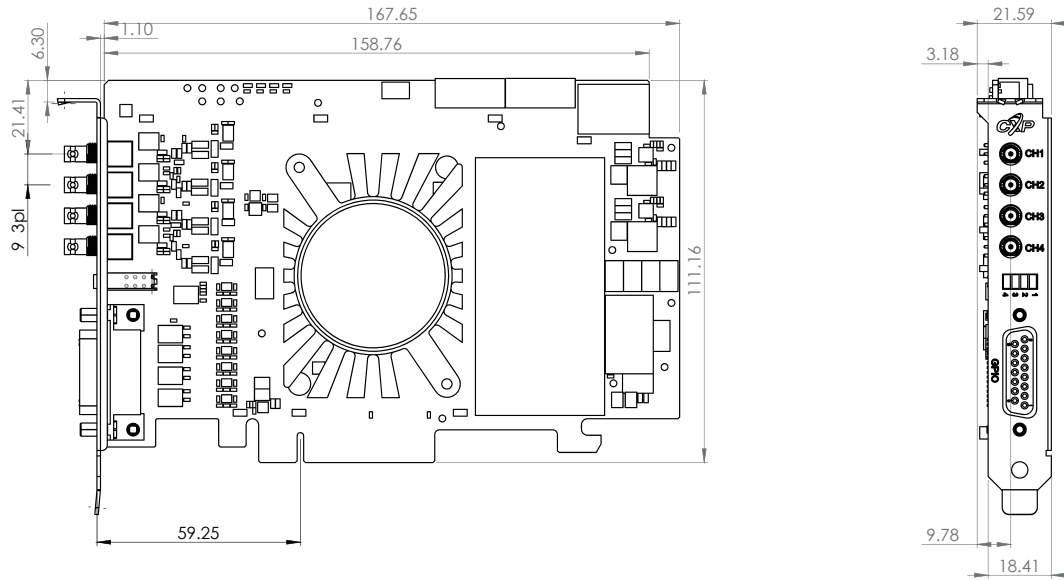

11.1.14 Chameleon II CoF

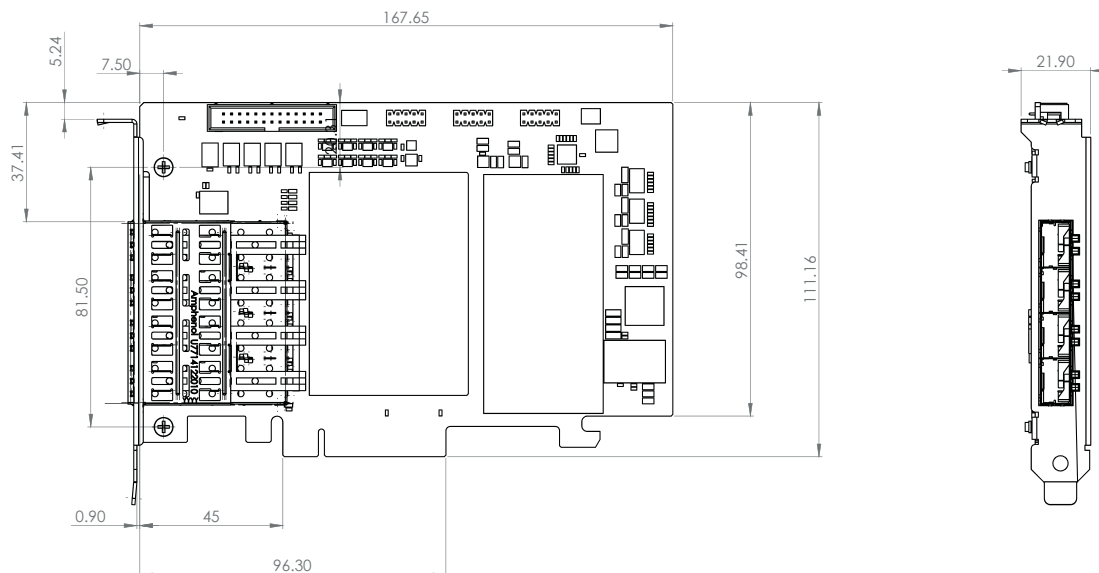

12 Power Specification

12.1 Absolute Maximum Ratings

Specification	Values
3.3 V power supply	-0.3 V to +3.7 V
12 V power supply	-0.3 V to 14 V

Table 23 – Absolute maximum electrical ratings

Card	Minimum voltage [V]	Maximum voltage [V]
LVDS	-0.3	3.6
Opto-isolated (in)	-6.0	60
Opto-isolated (out)	-7.0	70
TTL	-0.5	6.5
LVTTTL	-0.5	6.5

Table 24 – Absolute maximum ratings for GPIO

13 Installation & Configuration

13.1 Installation Instructions

Our cards can be installed onto any PCIe connector of the supported PCIe standard (See Table 2 – PCIe working modes)– PCIe working modes. It is important to note that your card should be installed **before** you install your software.

Installation steps are as follows:

1. Before installing, turn off the power of the computer and its peripherals.
2. Use an ESD-preventive glove, wrist or ankle strap and follow its instructions for use.
3. Make sure there is no dust or any other foreign matter inside the PCIe slot and the Frame Grabbers PCIe connector or blocking any of the connectors.
4. Firmly insert the cardboard into the PCIe connector of the motherboard.
5. Anchor the PCIe bracket to the computer chassis using an M3 screw.
6. Verify the card is inserted correctly into the PCIe slot.
7. Connect the external power supply to a dedicated connector (Predator II CoaXPress, Komodo II CoaXPress, Komodo III CoaXPress).
8. Power on the computer.
9. After OS is up, you will be asked to install a driver for the new Multimedia Device.
At this stage, you should Cancel the installation.

The compatible drivers for your card will be installed during the installation of our Vision Point software (Windows and Linux only). Multiple cards can be installed and used on a single computer – the exact number depends on the number of available PCIe slots.

NOTE: Inserting and/or removing KAYA PCI devices requires a reboot of the computer or restart of the "KAYA Instruments" service. After that, one may use Vision Point software or open API examples with KAYA devices.

13.2 CoaXPress Cards

Our CoaXPress cards (**Predator II CoaXPress, Komodo II CoaXPress, Komodo III CoaXPress** and **Chameleon II CoaXPress**) implement CoaXPress standard Micro-BNC connectors for CoaXPress interfaces. When attaching cables to your card you must use 75Ω coaxial cables. For best performance, it's recommended to use high-quality cables, such as Belden 4855A (12 Gb/s).

If you are using more than a single cable to connect to the same card, the cables you use must be of the same type and length.

13.2.1 Installing and Removing Micro-BNC Cables

Connecting a Micro-BNC cable is simple and straightforward. First, notice a pin on the male connector. An "L" shaped channel is cut out from the female connector. When connecting the cable push the connector onto the

male-end, making sure the pin and channel align. There should be no need to apply much pressure and it is advised to avoid doing so to prevent unnecessary damage to the cable or the card.

Figure no. 22 illustrates the process:

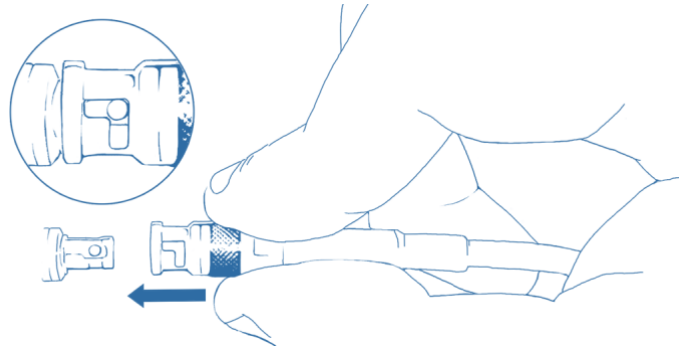

Figure 24 – Pushing the Micro-BNC connector into place

Once pushed all the way through, twist the connector clockwise. The pin will move in the channel locking the connector in position:

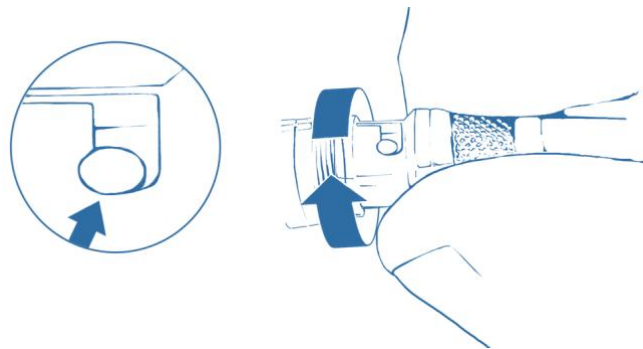

Figure 25 – Twisting the connector and securing it in position

To remove the cable, repeat the process from finish to start: twist the connector counter-clockwise and pull it out. Do not force the cable out! If you feel resistance check for the pin location in the channel. Adjust as needed and only then pull the cable out.

13.3 CLHS compatible and CoF Cards

13.3.1 Installing & Removing SFP+ Modules

The purpose of this section is to demonstrate how to install an SFP+ transceiver module, attach an optical network cable and remove an SFP+ transceiver module. It is necessary to understand the correct way of installing and removing an SFP+ transceiver, as correct operation can protect the module from being damaged and ensure its stable performance. Before removing or installing an SFP+ module, please follow the precautions and installation instructions.

13.3.2 Precautions

1. Use an ESD-preventive wrist or ankle strap and follow its instructions for use.
2. Make sure there is no dust or any other foreign matter inside the SFP+ module, or blocking any of the connectors.
3. Clean the optic surfaces of the fiber cables before plugging them into the optical ports of an SFP+ module.
4. Removing and inserting a module can shorten its useful life, so you should not remove and insert the module any more often than is necessary.
5. Insert the clean dust covers into the module after the cables are removed. Do not remove the dust plug until you are ready to attach the network interface cable.
6. Do not install or remove the SFP+ module with fiber-optic cables attached to it because of the potential of damaging the cable, the cable connector, or the optical interfaces in the module.
7. Disconnect all cables before removing or installing a module.
8. Place the removed module on an antistatic mat or a static shielding bag if you plan to return it to the factory.
9. Protect the line card by inserting clean module cage covers into the optical module cage when there is no module installed.
10. Keep the protective dust plugs installed in the unplugged fiber-optic cable connectors and the transceiver optical bores until you are ready to make a connection.

13.3.3 Installing the SFP+ Module

To install the SFP+ module, follow these steps:

1. The Predator II CLHS compatible, Predator II CoF, Komodo II CLHS compatible, Komodo II CoF Frame Grabbers and Chameleon II CoF supports the following SFP+ modules:
 - KY-SFP-10G31-10 – Allows up to 10 km connection over single-mode fiber cable.
 - KY-SFP-10G85-3M – Allows up to 300 m connection over multi-mode fiber cable.
2. Remove the dust plugs from the module as shown in figure 24 (a).
3. The SFP+ module has a bale clasp that is used to remove or install the SFP+ module.
4. Close the bale clasp before inserting the SFP+ module.
5. Line up the module with the port and slide it into the port as shown in figure 24 (b).
6. Make sure that the male connectors on the module will align with the female connectors inside the cage.
7. Verify that the modules are completely seated and secured in their assigned receptacles on the line card by firmly pushing on each module. In case the module is not completely seated and secured in the

receptacle, you will hear a click as the triangular pin on the bottom of the module snaps into the hole in the receptacle.

8. Follow the exact steps to insert an additional module into the camera's fiber interface.

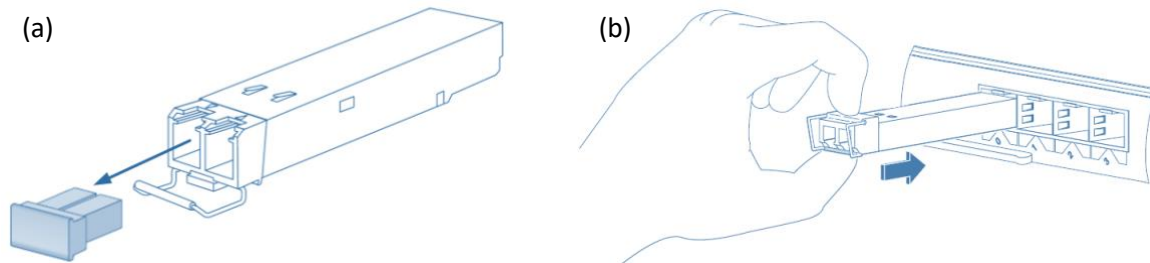

Figure 26 – SFP+ Module Installation.
 (a) bale clasp open and dust plug removed, (b) Installing an SFP+ Module into a port

13.3.4 Connecting the Interface Cable to the SFP+ Module

To properly connect the fiber optic cables, the following steps must be taken:

1. Remove the protective dust plugs from the fiber-optic cable connectors.
2. Perform the connection according to the instructions below:
 - a. Link 0 of the system must be always connected as controls are delivered with this port.
 - b. A Fiber connection must be done to the same port number all over the way from the camera to the Frame Grabber.
 - c. A fiber cable should match an SFP+ type. If a single-mode SFP+ is used a single mode fiber (yellow) should be attached to it. If a multi-mode SFP+ is used a multi-mode fiber (orange) should be attached.
 - d. On Fiber channel 0 both the TX and RX fiber cables must be connected. On channels 1 through 3, only one fiber cable should be connected. This cable is connected between TX output (Marked with TX or Arrow outwards the SFP+) on the camera and RX input (Marked with RX or Arrow inwards the SFP+) on the Frame Grabber, as shown in figure 25 (a).
 - e. If more than a single cable is used to connect to the same Frame Grabber, the cables must be of the same type and length.
3. Insert the fiber cable into the module, as shown in figure 25 (b).
4. Firmly push on each cable, until you will hear a click.
5. Connect the other side of the fiber cables to the camera's SFP+ module.
6. Turn the camera and the computer on and start your Vision Point software application.

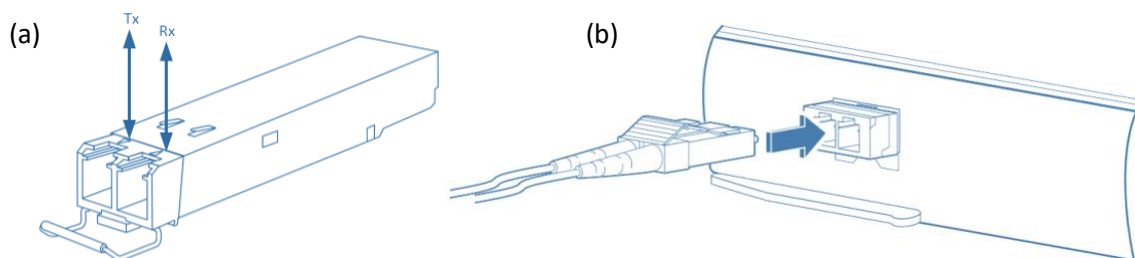

Figure 27 – Interface connecting to the SFP+ Module
 (a) SFP+ module with TX output and RX input marked, (b) Connecting the cable to SFP+ Module

13.3.5 Removing the SFP+ Module

1. Turn the camera and the computer off.
2. Disconnect and remove all interface cables from the ports.
3. Open the bale clasp on the SFP+ module with your index finger, or a small flat-blade screwdriver, in a downward direction, as shown in figure 25.
4. Grasp the module between your thumb and index finger and carefully remove it from the port, as shown in figure 26.
5. Insert the clean dust covers into the module, as shown in figure 26.

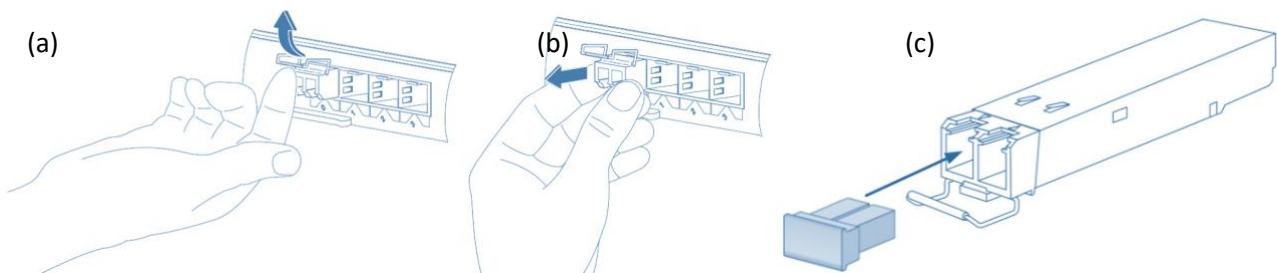

Figure 28 – Removing the SFP+ Module

(a) Opening the bale clasp of an SFP+ Module, (b) Removing an SFP+ Module from the port, (c) SFP+ Module with bale clasp open

13.4 Camera Connection Topologies

The Komodo II CoaXPress, Komodo II CLHS compatible, Komodo II CoF frame grabbers support multiple modes of configuration and system topologies:

Single Camera Topology:

Single, dual or quad links with a maximal bandwidth of 12.5 GB/s per link (10 GB/s for the CLHS). Total maximal throughput to PCIe is card-dependent, see Table 2 – PCIe working modes.



Figure 29 – Single camera topology

Dual Camera Topology:

Two single or dual links with a maximal bandwidth of 12.5 GB/s per link (10 GB/s for the CLHS). Total maximal throughput to PCIe is card-dependent, see Table 2 – PCIe working modes.

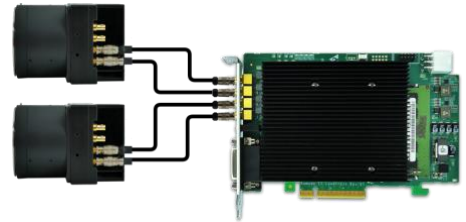

Figure 30 – Dual camera topology

Quad Camera Topology:

Four single links with a maximal bandwidth of 12.5 GB/s per link (10 GB/s for the CLHS). Total maximal throughput to PCIe is card-dependent, see Table 2 – PCIe working modes.

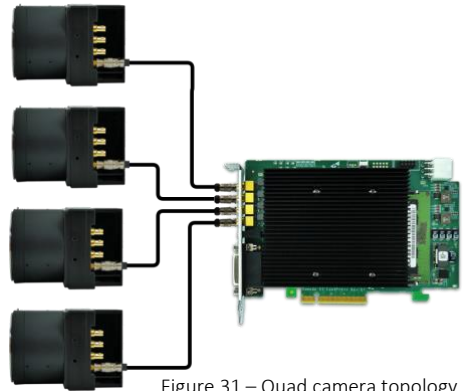

Figure 31 – Quad camera topology