

KAYA Frame Grabbers Feature Guide

January 2024
Rev 3.1



2255 Glades Rd., Suite 324A,
Boca Raton, FL 33431
USA
+1 (561) 689-2899

20 HaMesila St.
Nesher 3688520
Israel
+972 (72) 272-3500

info@kayainstruments.com
support@kayainstruments.com
www.kayainstruments.com

Table of Contents

1	Figures and Tables	1
1.1	List of Figures	1
1.2	List of Tables	2
2	Revision History	3
3	Introduction	4
3.1	Safety Precautions	4
3.2	Disclaimer	5
4	Overview	6
4.1	Document Scope	6
4.2	Directories and File Hierarchy	7
5	Hardware Information	8
6	Device General Control	9
6.1	Timestamp	10
6.2	Bandwidth Test	11
6.3	Fan control	13
7	Camera Discovery and PoCXP Control	14
7.1	Camera Discovery Process Overview	14
7.2	PoCXP Automatic Management	15
7.3	Manual PoCXP Control Configuration	18
7.4	Camera Discovery Mode	20
7.4.1	Camera discovery delay	22
7.4.2	Normal camera discovery process	23
7.4.3	Manual camera discovery	24
7.4.4	Silent discovery mode	25
7.4.5	Komodo 4R4T system configuration	26
8	Extended Stream Features	28
8.1	Camera Selector Parameter	28
8.2	Extended Stream Callback	29
9	Stream Control & Statistics	30
9.1	Transport Control	30
9.2	Transport Control	31
9.3	Serial Port Control	32
9.4	Acquisition Stream Statistics Parameters	33
9.4.1	Frame Acquisition Latency	34
10	Image Processing	35

10.1	Image Format Control	36
10.1.1	FIFO Threshold.....	37
10.1.2	Vertical decimation	38
10.1.3	Segment accumulation.....	39
10.1.4	Frames per stream	40
10.1.5	Bayer de-mosaic	41
10.1.6	Data Packing Mode.....	44
10.2	Color transformation	46
10.2.1	Monochrome image special case	47
11	I/O Controller	48
11.1	Camera Trigger	49
11.1.1	Camera Trigger activation mode	51
11.1.2	Camera Trigger signals filter.....	52
11.1.3	Camera Trigger Delay	53
11.1.4	Camera Trigger Event	54
11.1.5	Steps to properly configure Camera Triggers	55
11.2	Acquisition (Frame Grabber) Triggers	56
11.2.1	Trigger activation mode	58
11.2.2	Trigger signals filter	59
11.2.3	Trigger Delay.....	60
11.2.4	Trigger Event	61
11.2.5	Steps to properly configure Frame Grabber Triggers	62
11.3	Encoder trigger functionality.....	63
11.3.1	Encoder trigger filter	66
11.3.2	Encoder position and position trigger.....	67
11.3.3	Encoder output mode	68
11.3.4	Encoder Event.....	69
11.4	Timer trigger signals	70
11.4.1	Timer activation mode	72
11.4.2	Timer delay, duration and signal inversion	73
11.4.3	Timer Event	74
11.5	Auxiliary GPIO block	75
11.5.1	Digital I/O Event	78
11.6	User Output block	79
11.7	Trigger Source options	80
11.8	Trigger Controls Layout in Vision Point App.....	82

11.8.1	TriggerN Control	83
12	Protocol Specific Features (CoaXPress).....	86
12.1	CoaXPress Connectivity Test	86
12.2	CoaXPress Trigger Statistics.....	87
13	System Monitor Control	88
13.1	System Monitor Control	88
14	Replay Control	89
14.1	Replay Control	89
15	Protocol Specific Features (CLHS)	90
15.1	Pulse Message	90
15.2	Image Acquisition filter	92
15.3	Link Connection Counters	93
15.4	Metadata Insertion.....	94
15.4.1	Mode1	95
15.5	System Monitor Control	96
16	Protocol Specific Features (GigE)	97
16.1	Device Connection Control.....	97
17	Multiple Frame Grabber Synchronization	98

1 Figures and Tables

1.1 List of Figures

Figure 1 – Main directory and file hierarchy.....	7
Figure 2 – Examples and save directories.....	7
Figure 3 – Bandwidth test parameters in Vision Point App.....	12
Figure 4 – Fan control in Vision Point App.....	13
Figure 5 – Automatic PoCXP monitoring activate/deactivate in Vision Point App.....	15
Figure 6 – Automatic PoCXP management in Vision Point App.....	17
Figure 7 – Manual PoCXP control Toolbar Menu in Vision Point App.....	18
Figure 8 – Manual PoCXP controls in Vision Point App.....	19
Figure 9 – Camera discovery delay in Vision Point App.....	22
Figure 10 – Manual camera discovery configurations in Vision Point App.....	24
Figure 11 – Retransmission setup example.....	26
Figure 12 – Hardware based image processing pipeline.....	35
Figure 13 – Bayer filter example.....	41
Figure 14 – Bilinear de-mosaicking algorithm (Area scan).....	42
Figure 15 – Bilinear de-mosaicking algorithm (Line scan).....	43
Figure 16 – Packing of 8 bit pixels.....	44
Figure 17 – Packing of 10 bit pixels.....	44
Figure 18 – Packing of 12 bit pixels.....	44
Figure 19 – Packing of 14 bit pixels.....	45
Figure 20 – Packing of 16 bit pixels.....	45
Figure 21 – Camera trigger source.....	49
Figure 22 – Camera trigger structure.....	49
Figure 23 – Acquisition stream trigger source.....	56
Figure 24 – Acquisition stream trigger structure.....	56
Figure 25 – Encoder triggers structure.....	64
Figure 26 – Encoder channels.....	65
Figure 27 – Timer triggers structure.....	71
Figure 28 – Output inverters.....	73
Figure 29 – Digital I/O Line structure.....	77
Figure 30 – Camera Trigger Layout in Vision Point App.....	82
Figure 31 – Trigger Layout in Vision Point App.....	82
Figure 32 – TriggerN Control.....	83
Figure 33 – Frame Grabber synchronization wiring.....	98

1.2 List of Tables

Table 1 – Revision History.....	3
Table 2 – Hardware information parameters	8
Table 3 – Device Control parameters	9
Table 4 – Timestamp parameters	10
Table 5 – Bandwidth test parameters.....	11
Table 6 – Bandwidth test supported devices.....	12
Table 7 – Fan control parameters.....	13
Table 8 – Automatic PoCXP control parameters.....	16
Table 9 – Automatic PoCXP supported devices	17
Table 10 – Manual PoCXP control parameters	18
Table 11 – Camera discovery parameters	21
Table 12 – Retransmission configuration.....	27
Table 13 – Camera selector parameter	28
Table 14 – Extended stream callbacks parameters	29
Table 15 – Transport Layer Control Parameters.....	30
Table 16 – Transport Control Parameters	31
Table 17 – Serial port control parameters	32
Table 18 – Acquisition stream statistics parameters	33
Table 19 – Image Format control parameters	36
Table 20 – Color transformation control parameters.....	47
Table 21 – Camera Trigger parameters	50
Table 22 – Acquisition Triggers parameters	57
Table 23 – Available configurations for Encoders.....	63
Table 24 – Encoder selection options.....	63
Table 25 – Available configurations for Timers.....	70
Table 26 – Timer selection options.....	70
Table 27 – Available configurations for Input I/O	75
Table 28 – Line selection options.....	76
Table 29 – Available configurations for User outputs.....	79
Table 30 – User Output selection options	79
Table 31 – Frame Grabber I/O source	81
Table 32 – Available configurations for TriggerN Control.....	83
Table 33 – TriggerN selector.....	85
Table 34 – CoaXPress connection test parameters	86
Table 35 – CoaXPress trigger counters	87
Table 36 – System monitor parameters.....	88
Table 37 – Replay control parameters.....	89
Table 38 – Pulse Message control parameters.....	91
Table 39 – Image Acquisition Filter Control.....	92
Table 40 – CLHS link connection counters	93
Table 41 – System I/O input lines	95
Table 42 – Metadata format.....	95
Table 43 – Metadata control parameters.....	95
Table 44 – System monitor parameters.....	96
Table 45 – GigE connection configuration.....	97
Table 46 – Frame Grabber required settings.....	99

2 Revision History

Version	Date	Notes
1.0	24.06.2020	Initial release
2.0	14.10.2022	Added new sections: <ul style="list-style-type: none">- Serial port control- System monitor control (for CoaXPress and CLHS sections)- Replay control Added new parameters in multiple categories
3.0	02.01.2023	Updated Komodo 4R4T system configuration section
	01.2024	Added TriggerN section Updated Figure 11, Figure 21, Figure 23, Table 31

Table 1 – Revision History

3 Introduction

3.1 Safety Precautions

Please take the time to read through the precautions listed below in order to prevent preventable and unnecessary injuries and damage to you, other personnel or property. Read these safety instructions carefully prior to your first use of the product, as these precautions contain safety instructions that must be observed. After reading through this manual, be sure to follow it to prevent misuse of product.



Caution! Read Carefully and do not disregard these instructions.

In the event of a failure, disconnect the power supply

Disconnect the power supply immediately and contact our sales personnel for repair. Continuing to use the product in this state may result in a fire or electric shock.

If an unpleasant smell or smoking occurs, disconnect the power supply.

Disconnect the power supply immediately! Continuing to use the product in this state may result in a fire or electric shock. After verifying that no smoking is observed, contact our sales personnel for repair.

Do not disassemble, repair or modify the product.

This may result in a fire or electric shock due to a circuit shortage or heat generation. Contact our sales personnel prior to inspection, modification or repair.

Do not place the product on unstable surfaces.

Otherwise, it may drop or fall, resulting in injury to persons or the camera.

Do not use the product if dropped or damaged.

Otherwise, a fire or electric shock may occur.

Do not touch the product with metallic objects.

Otherwise, a fire or electric shock may occur.

Do not place the product in dusty or humid environments, nor where water may splash.

Otherwise, a fire or electric shock may occur.

Do not wet the product or touch it with wet hands.

Otherwise, the product may fail or it may cause a fire, smoking or electric shock.

Do not touch the gold-plated sections of the connectors on the product.

Otherwise, the surface of the connector may be contaminated by sweat or skin-oil, resulting in contact failure of a connector, malfunction, fire or electric shock due to static electricity discharge.

Do not use or place the product in the following locations.

- Unventilated areas such as closets or bookshelves.
- Near oils, smoke or steam.
- Next to heat sources.
- A closed (and not running) car where the temperature becomes high.
- Static electricity replete locations
- Near water or chemicals.

Otherwise, a fire, electric shock, accident or deformation may occur due to a short circuit or heat generation.

Do not place heavy objects on the product.

Otherwise, the product may be damaged.

Be sure to discharge static electricity from body before touching any sensitive electronic components.

The electronic circuits in your computer and the circuits on the *Iron* camera and the *Predator II* board are sensitive to static electricity and surges. Improper handling may seriously damage the circuits. In addition, do not let your clothing come in contact with the circuit boards or components. Otherwise, the product may be damaged.

3.2 Disclaimer

KAYA Instruments will assume no responsibility for any damage that may ensue by the use of this product for any purpose other than intended, as previously stated. Without detracting from what was previously written, please be advised that the company will take no responsibility for any damages caused by:

- Earthquake, thunderstrike, natural disasters, fire caused by use beyond our control, willful and/or accidental misuse and/or use under other abnormal and/or unreasonable conditions.
- Secondary damages caused by the use of this product or its unusable state (business interruption or others).
- Use of this product in any manner that contradicts this manual or malfunctions that may occur due to connection to other devices. Damage to this product that is out of our control or failure due to modification.
- Accidents and/or third parties that may be involved.

Additionally, **KAYA Instruments** assumes no responsibility or liability for:

- Erasure or corruption of data caused by the use of this product.
- Any consequences or other abnormalities following the use of this product.

Repairs to this product are carried out by replacing it on a chargeable basis and not by repairing the faulty device. Non-chargeable replacement is offered for initial failure, as long as it is reported no later than two weeks post-delivery of the product.

4 Overview

4.1 Document Scope

The purpose of this document is to describe the provided functionality and features of KAYA's Frame Grabbers. Camera connectivity and streaming can be easily achieved in few easy steps with almost no configurations. Camera control is provided through standard Gen<I>Cam interface subordinate to camera's descriptive schema (xml) file. Advanced features and custom configurations can be done to enhance streaming and image processing of camera output. These are available using interactive Gen<I>Cam interface and provided API functionality. SDK functionality is subject to hardware device and burned firmware capabilities. A firmware and software upgrade may be needed to support complete functionality set.

For more information about API functionality and SDK usage please refer to "Vision Point API Data Book". All the parameters described in this document are Frame Grabber parameters and can be accessed from GUI Frame Grabber tab in the project navigator or from API using `KYFG_SetGrabberValue` and `KYFG_GetGrabberValue` function variations.

4.2 Directories and File Hierarchy

The directory hierarchy of Vision Point App as can be seen after a complete installation:

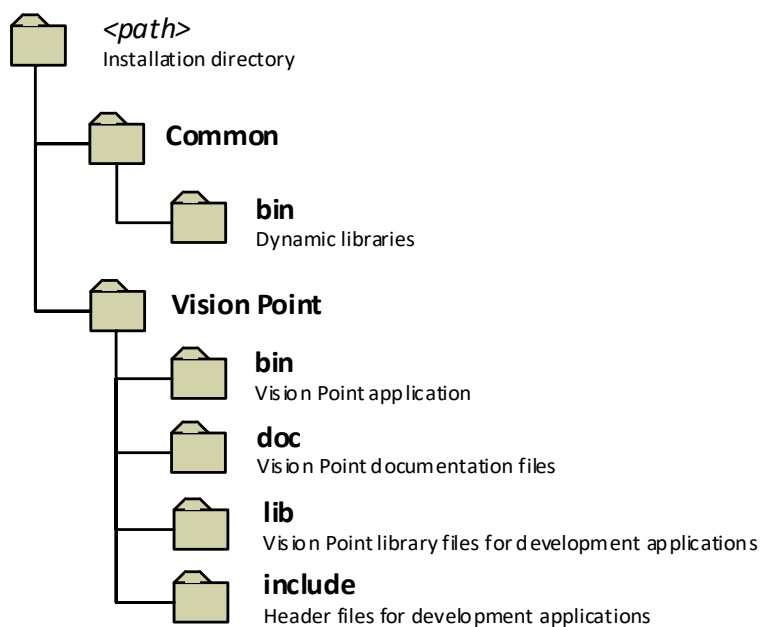

Figure 1 – Main directory and file hierarchy

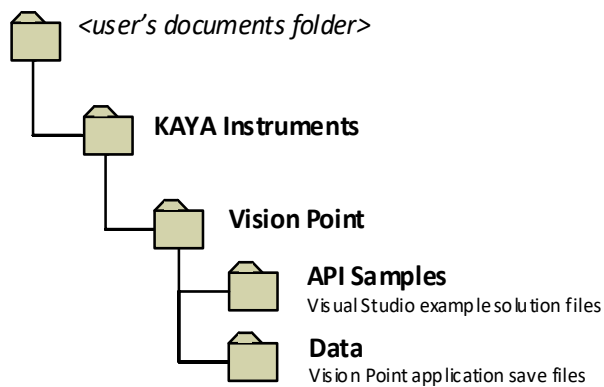

Figure 2 – Examples and save directories

5 Hardware Information

The Hardware information contains parameters describing the currently connected hardware device and includes device capabilities, basic connectivity details and currently running firmware. This information can be used to identify the specific card and its capabilities and inform if a firmware update is needed to support complete functionality set. It can also help to indicate about certain performance issues. The hardware information parameters can be found in the following table:

Parameter	Description	Gen<i>Cam name	Type	Possible values		Remarks
				Value	Gen<i>Cam name	
Gen<i>Cam Category: HardwareInformation						
Firmware Version	The firmware version of the device	DeviceFirmwareVersion	String			
Serial Number	Serial Number of the device	DeviceSerialNumber	String			
Device Revision	Revision of the device	DeviceRevision	Integer			
Maximum Links	Maximum available links on the device	MaxLinks	Integer			
Device PCIe Generation	Supported generation of connected PCIe	DevicePciGeneration	Integer	1,2,3		
PCIe lanes	Number of connected PCIe lanes	DevicePciLanes	Integer	1,2,4,8		
Min. PCIe generation required	Recommended minimum PCIe generation	DevicePciGenerationMin	Integer			
Min. PCIe lanes required	Recommended minimum PCIe lanes	DevicePciLanesMin	Integer			
Device Temperature	Device CPU Temperature	DeviceTemperature	Integer			Temperature is in °C
Maximum available cameras	Maximum supported cameras by the device	MaxCameras	Integer			
Firmware status	Status of the firmware in the device	DeviceFirmwareStatus	String			
Device status	Status of the device	DeviceStatus	String			

Table 2 – Hardware information parameters

6 Device General Control

Parameter	Description	Gen<i></i>Cam name	Type	Possible values		Remarks
				Value	Gen<i></i>Cam name	
Gen<i></i>Cam Category: DeviceControl						
Device User ID	User-programmable device identifier	DeviceUserID	String			
Device stream control reset	Reset the device's stream control	DeviceStreamControlReset	Command	1 - Activate		
Device reset	Reset the device	DeviceReset	Command	1 - Activate		
Save 'Device User ID'	Writes 'Device User ID' to hardware	DeviceUserIDWrite	Command	1 - Activate		

Table 3 – Device Control parameters

6.1 Timestamp

KAYA Frame Grabbers include a Timestamp mechanism for tagging frames and I/O events. Timestamp parameter reflects a global counter value, in nanoseconds. The counter value is represented by 64bit unsigned integer which wraps around when maximum value is reached and can be read from the “Timestamp” register. “TimestampReset” command force resets the timestamp counter to 0.

The timestamp counter may not be stopped but the “TimestampLatch” may capture the counter value in the moment it is issued. The captured value will be stored in 64bit unsigned integer register “TimestampLatchValue” until the next “TimestampLatch” command is issued. The timestamp parameters are summarized in the following table:

Parameter	Description	Gen<i>Cam name	Type	Possible values		Remarks
				Value	Gen<i>Cam name	
Gen<i>Cam Category: DeviceControl						
Timestamp	Current value of the device timestamp counter. The same timestamp counter is used for tagging images and I/O events	Timestamp	Integer (8 bytes)			Value in nanoseconds
Timestamp Reset	Resets the current value of the device timestamp counter	TimestampReset	Command	1 - Activate		
Timestamp Latch	Latches the current timestamp counter into TimestampLatchValue	TimestampLatch	Command	1 - Activate		
Timestamp latched value	Latched value of the timestamp counter	TimestampLatchValue	Integer (8 bytes)			Value in nanoseconds
Device User ID	User-programmable device identifier	DeviceUserID	String			
Device stream control reset	Reset the device's stream control	DeviceStreamControlReset	Command	1 - Activate		
Device reset	Reset the device	DeviceReset	Command	1 - Activate		
Save 'Device User ID'	Writes 'Device User ID' to hardware	DeviceUserIDWrite	Command	1 - Activate		

Table 4 – Timestamp parameters

6.2 Bandwidth Test

KAYA Frame Grabbers also include a Bandwidth test feature for PCIe throughput testing. This feature allows the user to set the desired buffer size and execute a bandwidth test for currently selected Frame Grabber. This test should be performed as a standalone test, without any streaming during its execution. Succession of the bandwidth test will result in “Finished” status while abortion of the test will result in “Stopped” status. During the test the status will change to “Running”. Please refer to Table 6 for additional information regarding the devices, which support the described feature. The bandwidth test parameters are summarized in Table 5.

Parameter	Description	Gen<i>Cam name	Type	Possible values		Remarks
				Value	Gen<i>Cam name	
Gen<i>Cam Category: DeviceControl/ BandwidthTest						
Reference buffer size (Bytes)	Size in Bytes of reference buffer used for bandwidth test	BandwidthTestReferenceBufferSize	Integer			
Payload buffer width	Width of payload buffer(s) used for bandwidth test	BandwidthTestPayloadBufferWidth	Integer			
Payload buffer height	Height of payload buffer(s) used for bandwidth test	BandwidthTestPayloadBufferHeight	Integer			
Payload buffer size (MB)	Size in MB of payload buffer(s) used for bandwidth test	BandwidthTestPayloadBufferSize	Integer			
Payload buffers count	Number of buffers used for bandwidth test	BandwidthTestPayloadBuffersCount	Integer			
Perform bandwidth test	Perform bandwidth test	BandwidthTestPerform	Command	1 - Activate		
Abort bandwidth test	Abort bandwidth test	BandwidthTestAbort	Command	1 - Activate		
Bandwidth test status	Current status of bandwidth test	BandwidthTestStatus	Enumeration	0 1 2 3 4	Stopped Started Running Finished Error	
Average transfer time (usec)	Average time for payload buffer(s) transfer used for bandwidth test	BandwidthTestAverageTime	Float			
Average transfer speed (MB/sec)	Average speed of payload buffer(s) transfer used for bandwidth test	BandwidthTestAverageSpeed	Float			

Table 5 – Bandwidth test parameters

Device Control		
Bandwidth Test		
Reference buffer size (Bytes)	256	<input type="checkbox"/>
Payload buffer width	1048576	<input type="checkbox"/>
Payload buffer height	12000	<input type="checkbox"/>
Payload buffer size (MB)	12,000.000000	<input checked="" type="checkbox"/>
Payload buffers count	1	<input type="checkbox"/>
Perform bandwidth test	Execute	<input checked="" type="checkbox"/>
Abort bandwidth test	Execute	<input type="checkbox"/>
Bandwidth test status	Running	<input type="checkbox"/>
Average transfer time (usec)	1,959,384.384000	<input type="checkbox"/>
Average transfer speed (MB/sec)	6,124.372583	<input type="checkbox"/>

Figure 3 – Bandwidth test parameters in Vision Point App

Please refer to the following table for additional information regarding the devices, which support the described feature.

Hardware device	Firmware version	Software version
Komodo CoaXPress Quad and Octo	Starting 4.11.6	Starting Vision Point 2020.1
Komodo II CoaXPress	Currently not implemented	Currently not implemented
Predator CoaXPress	Not supported	Not supported
Predator II CoaXPress	Currently not implemented	Currently not implemented
Komodo Fiber	Currently not implemented	Currently not implemented
Komodo Fiber CLHS compatible	Starting 4.21.2 (SFP)	Starting Vision Point 2020.1
Komodo 10GigE	Starting 4.5.2	Starting Vision Point 2020.1
Komodo II CLHS compatible	Currently not implemented	Currently not implemented

Table 6 – Bandwidth test supported devices

6.3 Fan control

The fan control parameters are described in Table 7 and the figure below, as they appear in Vision Point application.

Parameter	Description	Gen<i>Cam name	Type	Possible values		Remarks
				Value	Gen<i>Cam name	
Gen<i>Cam Category: DeviceControl \ FanControl						
PWM frequency (KHz)	Fan control clock frequency in KHz	PWM_frequency	Float			In units of KHz
PWM duty cycle (%)	Fan duty cycle in percentage to PWM period	PWM_duty_cycle	Integer			
Hysteretic FAN off threshold	When card reaches the min threshold it will turn off the FAN	PWM_min_temp	Float			
Hysteretic FAN on threshold	When card reaches the max threshold it will turn on the FAN	PWM_max_temp	Float			

Table 7 – Fan control parameters

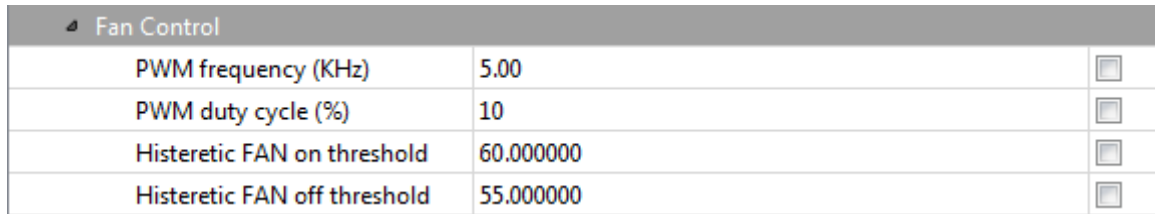

Fan Control			
PWM frequency (KHz)	5.00		<input type="checkbox"/>
PWM duty cycle (%)	10		<input type="checkbox"/>
Histeretic FAN on threshold	60.000000		<input type="checkbox"/>
Histeretic FAN off threshold	55.000000		<input type="checkbox"/>

Figure 4 – Fan control in Vision Point App

7 Camera Discovery and PoCXP Control

7.1 Camera Discovery Process Overview

KAYA's Frame Grabbers API provides different camera discovery modes. By default, the Normal discovery mode is active which includes camera negotiation, reset sequence and setting the camera's default speed and topology. The different camera discovery modes are available by setting existing configurations. Manual control and automatic management of PoCXP are provided for CoaXPress cameras which draw power via coax cables, instead of external power supply.

7.2 PoCXP Automatic Management

Starting from Vision Point API 5.0 the PoCXP management has been changed and automatic power management was improved: KAYA's Software stack is now constantly monitoring an available connection state and turning PoCXP on/off automatically. The power of a camera will be turned on in the background by the Frame Grabber, even when no Vision Point or other KAYA API based application is running.

This improved feature makes connection to supporting CoaXPress cameras quick and effortless. This feature is subject to compatible hardware, firmware and software support. Actual availability in a particular setup (camera, grabber card, firmware and software) can be checked by reading Grabber parameter "PoCXPAutoAvailable". A positive result means the feature is supported; otherwise, this feature is not supported by the given setup.

"PoCXPAutoActive" can be used to activate/deactivate this feature on a particular grabber during application run-time. In addition, the entire functionality of automatic PoCXP monitoring can be activated and deactivated using the following option found in Vision Point-> Tools-> Options. Please note that this global setting only takes effect after a system reboot and is applied to all connected frame grabbers. It is possible deactivate this functionality globally and still activate it locally on a particular grabber using aforementioned "PoCXPAutoActive" command at run-time. This command applies to a grabber immediately.

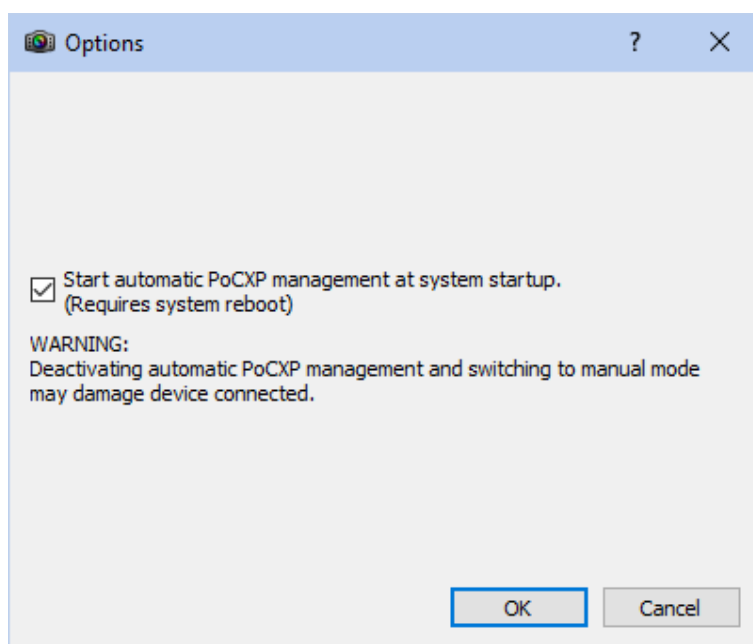

Figure 5 – Automatic PoCXP monitoring activate/deactivate in Vision Point App

If the feature is not supported/deactivated, legacy manual PoCXP management should be used as described in section 7.3. In case the feature is supported and has been activated the following commands can be used to start/stop camera connection monitoring and change PoCXP state according to the presence of a camera on a given CoaXPress channel.

1. To forcibly set PoCXP state to OFF execute command "CxpPoCxpTurnOff". Found at the Vision Point GUI at:
 Frame Grabber tab → DeviceControl → CxpPoCxpHostConnectionSelector → CxpPoCxpTurnOff
2. To activate automatic power management, execute command "CxpPoCxpAuto". Found at the Vision Point GUI:
 Frame Grabber tab → DeviceControl → CxpPoCxpHostConnectionSelector → CxpPoCxpAuto

3. To read current state of the PoCXP monitoring read the "CxpPoCxpStatus" parameter. Can be found at:

Frame Grabber tab -> DeviceControl → CxpPoCxpHostConnectionSelector → CxpPoCxpAuto

These three parameters are implemented according to GenICam_SFNC standard document with the following addition: CXP channels affected by these commands depend on the current state of the "CxpPoCxpHostConnectionSelector" parameter value. When this value is "-1" the command is applied to all available CXP channels, otherwise they are applied only to single channel specified by "CxpPoCxpHostConnectionSelector".

Parameter	Description	Gen<i>Cam name	Type	Possible values		Remarks
				Value	Gen<i>Cam name	
Gen<i>Cam Category: DeviceControl						
PoCXPAuto available	Indicates whether PoCXP can be controlled automatically	PoCXPAutoAvailable	Enumeration	0 1	PoCXPAutoAvai lableOff PoCXPAutOn	
CxpPoCxpHostCo nnectionSelector	PoCXP connection selector	CxpPoCxpHostConn ectionSelector	Enumeration (Selector)	-1 0 1 2 3 4 5 6 7	All Link0 Link1 Link2 Link3 Link4 Link5 Link6 Link7	
PoCXPAutoActive	Activates / deactivates automatic PoCXP	PoCXPAutoActive [CxpPoCxpHostCon nectionSelector]	Boolean	0 1	False True	
CxpPoCxpAuto	Activate automatic control of the Power over CoaXPress (PoCXP) for the Link	CxpPoCxpAuto [CxpPoCxpHostCon nectionSelector]	Command			
CxpPoCxpTurnOff	Disable Power over CoaXPress (PoCXP) for the Link	CxpPoCxpTurnOff [CxpPoCxpHostCon nectionSelector]	Command			
CxpPoCxpStatus	Returns the Power over CoaXPress (PoCXP) status of the Device link	CxpPoCxpStatus [CxpPoCxpHostCon nectionSelector]	Enumeration	-1 0 1 2	Mixed Auto Off Tripped	Mixed statuses Automatically managed Forced Off Tripped

Table 8 – Automatic PoCXP control parameters

NOTE: that legacy Grabber parameters "PoCXP0" ... "PoCXP7" are still available when automatic PoCXP is active but they become read-only in this case. You can read values of those parameters to get the current state of PoCXP on each channel.

PoCXP 0 control	On	<input type="checkbox"/>
PoCXP 1 control	Off	<input type="checkbox"/>
PoCXP 2 control	Off	<input type="checkbox"/>
PoCXP 3 control	Off	<input type="checkbox"/>
PoCXP 4 control	Off	<input type="checkbox"/>
PoCXP 5 control	Off	<input type="checkbox"/>
PoCXP 6 control	Off	<input type="checkbox"/>
PoCXP 7 control	Off	<input type="checkbox"/>
PoCXPAuto available	Yes	<input type="checkbox"/>
PoCXPAuto Active	<input checked="" type="checkbox"/> True	<input type="checkbox"/>
▼ CxpPoCxpHostConnectionSelector	All CoaXPress physical host connecti...	<input type="checkbox"/>
CxpPoCxpAuto	Execute	<input type="checkbox"/>
CxpPoCxpTurnOff	Execute	<input type="checkbox"/>
CxpPoCxpStatus	Automatically managed	<input type="checkbox"/>

Figure 6 – Automatic PoCXP management in Vision Point App

Please refer to the following table for additional information regarding the CoaXPress devices, which support the described feature.

Hardware device	Firmware version	Software version
Komodo CoaXPress Quad and Octo	Starting 4.11	Automatic power monitoring support Note: Starting from hardware revision no. 3
Komodo II CoaXPress	All firmware versions	Automatic power monitoring support
Predator CoaXPress	Not supported	No power monitoring support Please refer to Manual PoXCP control section
Predator II CoaXPress	All firmware versions	Automatic power monitoring support

Table 9 – Automatic PoCXP supported devices

7.3 Manual PoCXP Control Configuration

This section describes the manual control of the PoCXP feature, provided by using the dedicated functions via GUI and API.

Parameter	Description	Gen<i></i>Cam name	Type	Possible values		Remarks
				Value	Gen<i></i>Cam name	
Gen<i></i>Cam Category: DeviceControl						
PoCXP 0 control	Frame Grabber PoCXP channel 0 control	PoCXP0	Enumeration	0 1	PoCXPOff PoCXPOn	
PoCXP 1 control	Frame Grabber PoCXP channel 1 control	PoCXP1	Enumeration	0 1	PoCXPOff PoCXPOn	
PoCXP 2 control	Frame Grabber PoCXP channel 2 control	PoCXP2	Enumeration	0 1	PoCXPOff PoCXPOn	
PoCXP 3 control	Frame Grabber PoCXP channel 3 control	PoCXP3	Enumeration	0 1	PoCXPOff PoCXPOn	
PoCXP 4 control	Frame Grabber PoCXP channel 4 control	PoCXP4	Enumeration	0 1	PoCXPOff PoCXPOn	
PoCXP 5 control	Frame Grabber PoCXP channel 5 control	PoCXP5	Enumeration	0 1	PoCXPOff PoCXPOn	
PoCXP 6 control	Frame Grabber PoCXP channel 6 control	PoCXP6	Enumeration	0 1	PoCXPOff PoCXPOn	

Table 10 – Manual PoCXP control parameters



To change PoCXP using API the “PoCXPx” (x determines the Frame Grabber link index) parameter should be set to “PoCXPOn” or “PoCXPOff”.

Example: To turn ON power of Frame Grabber link 2, the following function call may be used:

```
KYFG_SetGrabberValueEnum_ByValueName(grabberHandle, "PoCXP2", "PoCXPOn");
```

NOTE: Another option is to use function KYFG_SetGrabberValueEnum() using numeric values 0 and 1.

In order to control manually Power over CoaXPress, use the following Toolbar Menu button:

- To enable PoCXP press the  button – this will enable PoCXP to all links.
- To disable PoCXP press the  button – this will disable PoCXP to all links.

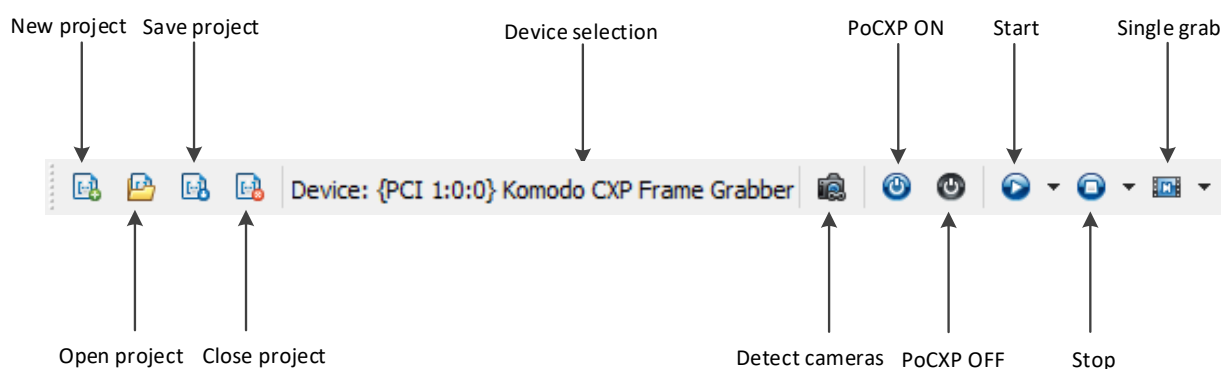

Figure 7 – Manual PoCXP control Toolbar Menu in Vision Point App

To control individual PoCXP channel follow the PoCXP controls located under the “Frame Grabber Control” category as described in Figure 8.

NOTE: "Off" is the display name of this enumeration, the machine name is "PoCXPOff", and "PoCXPOn" is name of value that will switch power over CXP to "ON".

PoCXP 0 control	On	<input checked="" type="checkbox"/>
PoCXP 1 control	Off	<input type="checkbox"/>
PoCXP 2 control	Off	<input type="checkbox"/>
PoCXP 3 control	Off	<input type="checkbox"/>
PoCXP 4 control	Off	<input type="checkbox"/>
PoCXP 5 control	Off	<input type="checkbox"/>
PoCXP 6 control	Off	<input type="checkbox"/>
PoCXP 7 control	Off	<input type="checkbox"/>

Figure 8 – Manual PoCXP controls in Vision Point App

⚠ Caution: Manually enabling PoCXP will drive 24V to all the Frame Grabber ports. Avoid hot plugging the camera while the PoCXP was manually enabled to reduce the risk of camera damage.

7.4 Camera Discovery Mode

Several discovery modes are provided to accommodate different camera discovery sequences and initialization processes. Some modes provide full camera initialization by negotiation and setting of default values. Others pre-define a connection or just search for connected cameras. Each mode is used for specific scenario and might yield a different result.

After a discovery mode is configured, initiate the scanning process using the KYFG_CameraScan() function or using the “Scan Cameras”  button in Vision Point App. The camera discovery parameters are described in Table 11.

Parameter	Description	Gen<i>Cam name	Type	Possible values		Remarks
				Value	Gen<i>Cam name	
Gen<i>Cam Category: DeviceControl						
Camera Discovery Delay	Time delay before start of camera discovery process	CameraDiscoveryDelay	Integer			In units of milliseconds (ms) Timeout to allow all connected cameras to power up and detected
Silent Discovery Mode	Silent camera discovery process without resetting any camera parameters. Only search for existing camera connection	SilentDiscovery	Enumeration	0	Off	Please refer to 0
				1	On	Silent discovery mode section for more information
Camera Command Timeout	Indicates the command timeout of all links in microseconds(us)	DeviceLinkCommandTimeout	Integer			If no response from the camera upon timeout end, a communication error will occur
Gen<i>Cam Category: ExtendedStreamFeatures \ ManualCameraDetection						
Manual Camera Mode		ManualCameraMode [CameraSelector]	Enumeration	0	Off	Please refer to 7.4.3 Manual camera discovery section for more information
				1	On	
Manual Camera Connection Config		ManualCameraConnectionConfig [CameraSelector]	Enumeration	0x10028	x1_CXP_1	Values are similar to “ConnectionConfig” parameter describing camera speed and topology
				0x10030	x1_CXP_2	
				0x10038	x1_CXP_3	
				0x10040	x1_CXP_5	
				0x10048	x1_CXP_6	
				0x10050	x1_10G	
				0x10058	x1_12G	
				0x20028	x2_CXP_1	
				0x20030	x2_CXP_2	
				0x20038	x2_CXP_3	
				0x20040	x2_CXP_5	
				0x20048	x2_CXP_6	
				0x20050	x2_10G	
				0x20058	x2_12G	
				0x40028	x4_CXP_1	
0x40030	x4_CXP_2					
0x40038	x4_CXP_3					
0x40040	x4_CXP_5					

0x40048	x4_CXP_6
0x40050	x4_10G
0x40058	x4_12G
0x80028	x8_CXP_1
0x80030	x8_CXP_2
0x80038	x8_CXP_3
0x80040	x8_CXP_5
0x80048	x8_CXP_6
0x80050	x8_10G
0x80058	x8_12G

Manual Camera Channel Selector	Selects the camera channel for which to configure the physical Frame Grabber link	ManualCameraChannel Selector [CameraSelector]	Enumeration	0 1 2 3	CameraChannel0 CameraChannel1 CameraChannel2 CameraChannel3
Manual Camera Physical Frame Grabber Link	Physical Frame Grabber link index, where the camera channel is connected.	ManualCameraFGLink [CameraSelector] [ManualCameraChannelSelector]		0 - < *MAX_FG_LINKS -1 >	
Camera Manifest File Path	Indicates the File Path to the GenICam XML camera description file	CameraManifestFilePath [CameraSelector]	String		

Table 11 – Camera discovery parameters

* MAX_FG_LINKS – number of physical Frame Grabber RX links

7.4.1 Camera discovery delay

The camera discovery delay sets the delay time before camera discovery is initiated. The discovery delay is set in milliseconds and simply waits the specified amount of time after camera scan call is initiated. At the end of the specified period, the camera discovery process will initiate according to the configured camera discovery mode.

Device Control		
Camera Discovery Delay	2000	<input checked="" type="checkbox"/>
Camera Command Timeout	400,000.000	<input type="checkbox"/>
Silent Discovery Mode	Off	<input type="checkbox"/>

Figure 9 – Camera discovery delay in Vision Point App

7.4.2 Normal camera discovery process

The Frame Grabber card will power up with PoCXP disabled. PoCXP will be re-enabled during camera discovery process for PoCXP compatible links. Normal camera discovery mode includes camera negotiation, reset sequence and setting the camera's default speed and topology.

By default, camera discovery will be terminated a short while after first camera was detected. If multiple cameras are powered and warmed-up at the time of camera discovery, they will all be detected (up to 8 cameras can be connected and discovered simultaneously, depending on type of the Frame Grabber and active firmware). Different cameras may have different boot-up times, until they are warmed up and ready for operation. In order to successfully detect such cameras a discovery delay should be optimized to match cameras' boot-up time.

Discovery process might take up to a minute to complete, which might hang up host application. To avoid such behavior, one might first manually enable the PoCXP, wait for the cameras to boot-up and then execute camera discovery process with short delay parameter.

7.4.3 Manual camera discovery

Manual camera discovery is to be done with the presumption that camera connectivity topology and communication speed is known for current discovery session. Generally, Manual discovery is much faster and less restrictive. Nevertheless, wrong Manual connectivity configurations might yield in unknown results and insufficient camera initialization. Manual discovery process steps:

1. Determine the camera speed, number of links and order of connection between camera channels and Frame Grabber links.
2. Select the “CameraSelector” value for each camera wished to be connected and change “ManualCameraMode” to “On” state to enable Manual discovery.
3. Set the “ManualCameraConnectionConfig” to determine the number of camera channels and current camera speed.
4. For each physical connection (total amount defined by “ManualCameraConnectionConfig”), select camera channel using “ManualCameraChannelSelector”. Afterwards determine the correct Frame Grabber link, to which the camera channel is attached, using “ManualCameraFGLink” configuration parameter.
5. Now camera scan can be initiated using the KYFG_CameraScan() function.

Manual camera detection		
Manual Camera Mode	Off	<input type="checkbox"/>
Manual Camera Connection Config	1 Link 1.250 Gbps	<input type="checkbox"/>
Manual Camera Channel Selector	Camera Channel 0	<input type="checkbox"/>
Manual Camera FG Link	0	<input type="checkbox"/>

Figure 10 – Manual camera discovery configurations in Vision Point App

7.4.4 Silent discovery mode

Silent camera discovery process is mainly used for retransmit applications. A silent scan for connected cameras is made without resetting any camera parameters (i.e., no writes are made to the camera. Nevertheless, multiple reads are made). If needed, camera Reset sequence and speed configuration should be performed from external source before a camera scan can be initiated using this mode. To activate the Silent Discovery Mode the following steps should be taken:

1. Set the “SilentDiscovery” value to “On” using the KYFG_SetGrabberValue() function or one of the provided sub-functions.
2. Make sure camera is already configured and ready to be connected to. Take under account that no camera Reset or connection reconfiguration commands will be sent.
3. Now camera scan can be initiated using the KYFG_CameraScan() function.

7.4.5 Komodo 4R4T system configuration

The following configuration should be used with the Komodo or Predator Frame Grabber when setting up the Komodo4R4T transmit channels towards the Frame Grabber receive channels.

7.4.5.1 Setup

1. Insert the Komodo/Predator Frame Grabber and the Komodo 4R4T Frame Grabber into a PC and connect the power connectors of Komodo 4R4T Frame Grabber. The regular Frame Grabber and the Komodo4R4T Frame Grabber can be installed in a single computer, or in two different computers.
2. Connect a CoaXPress camera or a Chameleon Simulator to one or more of the 4 top DIN connectors (channels 0-3) of the Komodo4R4T using 4 DIN cables.
3. Using different DIN cables, connect the bottom DIN connectors (channels 4-7) of Komodo4R4T to a regular Frame Grabber.
4. Make sure the Komodo4R4T links are connected in the same order (e.g., data from link 0 will be forwarded to link 4 etc.). See the image below as reference.

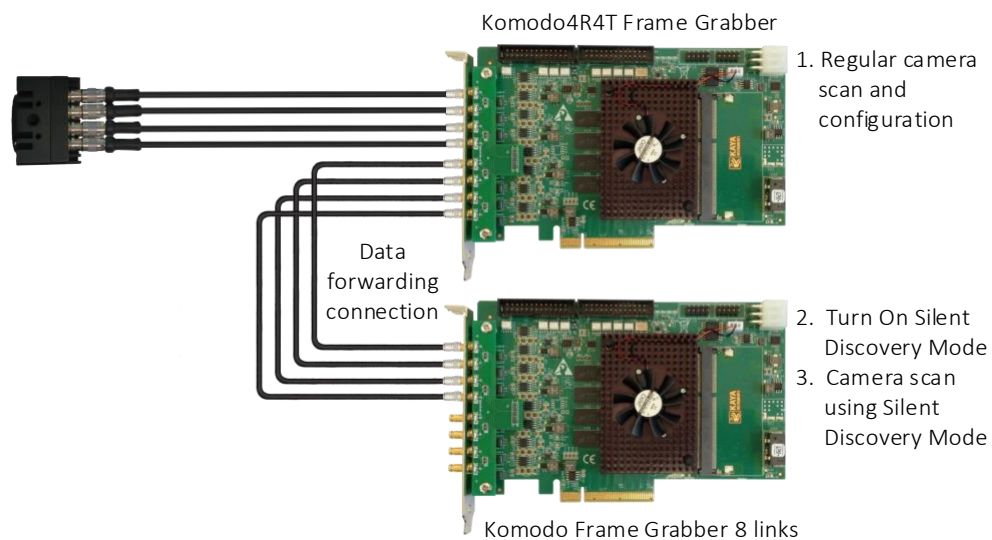

Figure 11 – Retransmission setup example

7.4.5.2 Configuration

The following steps should be performed on different instances of Vision Point application in order to configure and use the Komodo 4R4T Frame Grabber with regular Frame Grabber:

Step	Komodo 4R4T Frame Grabber	Komodo/Predator Frame Grabber
1	Open Vision Point application and select the Komodo4R4T device	-
2	-	Open an additional instance of the Vision Point application and select the Komodo/Predator regular Frame Grabber device
3	-	Activate the "Silent Discovery Mode". This option is located in Frame Grabber tab -> Device control category -> Silent Discovery Mode - ON
4	Scan and configure connected camera – this will initiate the camera correctly to be ready for silent discovery. NOTE: <i>I case you are using Chameleon Simulator, please open an additional instance if Vision Point application and configure the Chameleon Simulator to, before step no. 5</i>	-
5	-	Scan for connected camera
6	-	Start acquisition – this won't start the acquisition yet
7	Start acquisition – this will initiate acquisition on both Frame Grabbers	-

Table 12 – Retransmission configuration

8 Extended Stream Features

8.1 Camera Selector Parameter

Parameter	Description	Gen<i>Cam name	Type	Possible values		Remarks
				Value	Gen<i>Cam name	
Gen<i>Cam Category: ExtendedStreamFeatures						
Camera selector	Selects the camera for which the grabber parameters will relay to	CameraSelector	Integer (Selector)	0 - 7		

Table 13 – Camera selector parameter

“CameraSelector” is a grabber related parameter, which is responsible for updating the register set’s information, relevant to selected camera.

In order to view or change the value of grabber parameters which are subordinate per camera connection, the KYFG_GetGrabberValue() / KYFG_SetGrabberValue() functions (and their sub-functions) should be called with CAMHANDLE (Connected Camera Handle) instead of FGHANDLE (Frame Grabber Handle).

This will result in “CameraSelector” value change (according to input Connected Camera Handle) in addition to chosen parameter update request.

Alternatively, the “CameraSelector” value might first be selected and then the requested parameter can be changed using the KYFG_GetGrabberValue() / KYFG_SetGrabberValue() functions. This will result in the same manner, in case no other concurrent operation is interrupted between these two function calls.

Nevertheless, it is strongly recommended to pass CAMHANDLE (Connected Camera Handle) to relevant grabber API functions, instead of updating “CameraSelector” and then the parameter value. This is done to prevent multi-threading system issues!

8.2 Extended Stream Callback

Parameter	Description	Gen<i>Cam name	Type	Possible values		Remarks
				Value	Gen<i>Cam name	
Gen<i>Cam Category: ExtendedStreamFeatures						
Extended stream callbacks	Request extended stream callbacks with selected flags	ExtendedStreamCallbackMask	Integer (Selector)			
Frame Start Callbacks	Generate callback when DMA starts filling a frame (if supported by the HW)	FrameStartCallbacks [ExtendedStreamCallbackMask]	Boolean			

Table 14 – Extended stream callbacks parameters

9 Stream Control & Statistics

9.1 Transport Control

General settings for data transport (commands and stream) between the Frame Grabber and Camera.

Parameter	Description	Gen<i>Cam name	Type	Possible values		Remarks
				Value	Gen<i>Cam name	
Gen<i>Cam Category: ExtendedStreamFeatures \ TransportLayerControl						
Control Packet Data Size	Control commands packets max size	ControlPacketDataSize [CameraSelector]	Integer			Units in bytes. *See remarks
Stream Packet Data Size	Stream packets max size	StreamPacketDataSize [CameraSelector]	Integer			Units in bytes. *See remarks
Image1Stream ID	Id of the 1st stream	Image1StreamID [CameraSelector]	Integer			*See remarks

Table 15 – Transport Layer Control Parameters

* Setting parameter available only before camera discovery. This will override values retrieved from the camera bootstrap registers.

9.2 Transport Control

General settings for selecting the control method for the transfers for the remote device.

Parameter	Description	Gen<i>Cam name	Type	Possible values		Remarks
				Value	Gen<i>Cam name	
Gen<i>Cam Category: ExtendedStreamFeatures \ TransferControl						
Camera Transfer Control Mode	Selects the transfer control method over the connected camera	TransferControlMode [CameraSelector]	Enumeration	0	Automatic	Allows to choose whether acquisition commands will be issued to the camera automatically or initiated by user
				1	UserControlled	

Table 16 – Transport Control Parameters

9.3 Serial Port Control

Control over Serial Port communication channel features for supporting hardware with compatible firmware. Provides GenICam interface for clserkyi serial port API.

Parameter	Description	Gen<i>Cam name	Type	Possible values		Remarks
				Value	Gen<i>Cam name	
Gen<i>Cam Category: ExtendedStreamFeatures \ DeviceSerialPortControl						
Serial Port Selector	Selects device available serial port	DeviceSerialPortSelector	Enumeration	0	CameraLink	
				1	PeripheralGPIO_0	
				2	PeripheralGPIO_1	
				3	PeripheralGPIO_2	
				4	PeripheralGPIO_3	
				5	PeripheralGPIO_4	
				6	PeripheralGPIO_5	
				7	PeripheralGPIO_6	
Serial Port Number	Serial virtual COM port number	DeviceSerialPortNumber	Integer			
Serial Port Com Enable	Enables selected serial COM port channel	DeviceSerialPortComEnable	Boolean			

Table 17 – Serial port control parameters

9.4 Acquisition Stream Statistics Parameters

The acquisition stream statistics reflect the state of data flow in the Frame Grabber for each connected camera. These will be available only after a camera has been discovered and opened. Some parameters represent the quantity and period of received stream packets, while others count errors generated by corrupted data or data overflow.

These parameters may be read on each received frame for each camera stream to extract additional information and detect errors on acquisition path. The acquisition stream statistics are summarized in the following table.

Parameter	Description	Gen<i>Cam name	Type	Possible values		Remarks
				Value	Gen<i>Cam name	
Gen<i>Cam Category: ExtendedStreamFeatures \ StatisticsAndTests						
CRC Error Counter	CRC Errors Counter for received packets from camera	CRCErrorCounter [CameraSelector]	Integer			Errors are generated from corrupted data packets
RX Packet Counter	Total number of packets received from the camera	RXPacketCounter [CameraSelector]	Integer			
Drop Packet Counter	Number of packets dropped	DropPacketCounter [CameraSelector]	Integer			
RX Frame Counter	Number of received full image frames from camera	RXFrameCounter [CameraSelector]	Integer			
Drop Frame Counter	Number of image frames dropped due to buffer overflow	DropFrameCounter [CameraSelector]	Integer			
Start of frame acquisition latency	Latency measured from time the first frame byte received by Frame Grabber till it is requested by user	LatencyFrameStart [CameraSelector]	Integer			In units of microseconds (us)
End of frame acquisition latency	Latency measured from last frame byte received by Frame Grabber till it is requested by user	LatencyFrameEnd [CameraSelector]	Integer			In units of microseconds (us)
Acquisition frame rate	Actual acquisition frame rate calculated in correspondence to complete frames received by the Frame Grabber	AcquisitionFps [CameraSelector]	Float			In units of frames per second
Drop StreamId Counter	Number of frames dropped due to StreamId corruption	DropStreamIdCounter [CameraSelector]	Integer			
Connection Mask	Mask of physical links on which camera is detected	LinksConnectionMask [CameraSelector]	String			
FIFO Threshold	FIFO threshold, FIFO fill level	FifoThreshold [CameraSelector]	Integer			Threshold quantified in Bytes

Table 18 – Acquisition stream statistics parameters

9.4.1 Frame Acquisition Latency

Latency mechanism provides a criteria to determine time spend processing frame received from camera. Consequently calculates the period passed between the moments the camera has sent a new frame and when user received this data in Host Application. “LatencyFrameStart” holds time value in units of microseconds (usec) computed between the moments when a frame reception start in the Frame Grabber firmware and when user has requested this frame in Host Application. “LatencyFrameEnd” holds time value in units of microseconds (usec) computed between the moments when a complete frame has been received in firmware, and when user has requested this frame in Host Application.

10 Image Processing

KAYA's Frame Grabbers incorporate a hardware based image processing system that is able to deliver maximum frame rate without effecting system performance. The image processing features includes Bayer de-mosaic, color transformation matrix, decimation etc. The structure of the image processing pipeline can be seen in Figure 12.

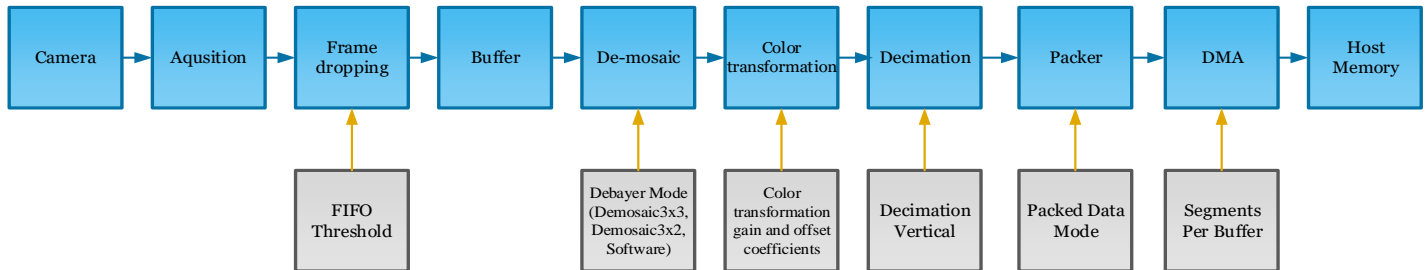

Figure 12 – Hardware based image processing pipeline

10.1 Image Format Control

The image format control is responsible for configuring some of the image processing features. The image format control can be found in the following table.

Parameter	Description	Gen<i>Cam name	Type	Possible values		Remarks
				Value	Gen<i>Cam name	
Gen<i>Cam Category: ExtendedStreamFeatures \ ImageFormatControl						
Transformation Pixel Format	Transformation of existing output image format to another selected format	PixelFormat [CameraSelector]	Enumeration	0x0000 0x0401 0x0402 0x0403 0x0404 0x0405 0x0311 0x0321 0x0331 0x0341	Normal RGB8 RGB10 RGB12 RGB14 RGB16 BayerGR8 BayerRG8 BayerGB8 BayerBG8	Conversion is possible according to input camera PixelFormat, resolution and HW capabilities
Width	Width of the image, to override the one provided by the remote device	Width [CameraSelector]	Integer			
Height	Height of the image, to override the one provided by the remote device	Height [CameraSelector]	Integer			
Debayer Mode	Selects the de-mosaicking algorithm	DebayerMode [CameraSelector]	Enumeration	0x0000 0x0002 0x0100	Demosaic3x3 Demosaic3x2 DemosaicSoftware	Please refer to notes
Segments per Buffer	Number of Lines/Frames to accumulate in a single buffer frame	SegmentsPerBuffer [CameraSelector]	Integer	≥ 1		This feature is mostly used for LineScan cameras. Please refer to Section 0, Segment accumulation for more details.
Decimation Vertical	Reduces image vertical resolution (height) by specified decimation factor	DecimationVertical [CameraSelector]	Integer	≥ 1		Frame lines amount will be reduced, by skipping them, to 1 / <decimation value> Default: 1 (no lines skipped)
Frames per stream	Number of frames to allocate in case of internal automatic buffer management	FramesPerStream [CameraSelector]	Integer			Please refer to section 0 for more details.
Packed Data Mode	Select algorithm for packing output stream data	PackedDataMode [CameraSelector]	Enumeration	0 1 3	Unpacked Packed_RowAligned32 Packed_RowAligned32_Reverse	Data packing output mode. Please refer to section 0 Data Packing Mode for more details

Table 19 – Image Format control parameters

NOTES:

1. A "Demosaic3x3" is a 3x3 hardware debayer that almost doesn't add any processing latency, 3x2 hardware debayer should be used for linescan camera with 2 rows. Software is 5x5 debayer implemented via OpenCV, notice it will slow down the acquisition frame rate substantially.
2. The captured images will be as bayer format raw data. Capturing images operation can be executed using API functions. More information about API functions can be found in "Vision_Point_API_Data_Book".

10.1.1 FIFO Threshold

A threshold on a fill level of on-board memory buffers to decide whenever to drop the frames in case the PCIe bandwidth is not enough to transfer the whole image stream. Larger values will result in larger frame latency but in longer frame recording till the dropping starts. A shorter value will result in lower latency but the frame dropping will start sooner. Use this parameter only if the PCIe bandwidth limits your stream, otherwise leave it at default value. Threshold default value is 32MB quantified in Bytes. The threshold value depends on hardware capabilities and mounted memory banks.

10.1.2 Vertical decimation

Allows the decimation of complete data lines acquired by the Frame Grabber. The decimation value represents number of lines that will be skipped for each accepted line, thus shrinking the input image vertically. For example, to skip every second line set this parameter to 1.

Note that this parameter may be changed while streaming data. Due to that fact, buffer allocation is not affected by this operation, thus Host Application must track changes in received buffer data size!

10.1.3 Segment accumulation

Stream configuration to capture several frames/lines before an event signal is received in software. This feature is mostly used for LineScan cameras – several lines are accumulated before software receives indication signal on new data acquisition. This prevents the software from receiving lines too frequently thus relieving the CPU operation.

“SegmentsPerBuffer” parameter should be set using `KYFG_SetGrabberValue()` only after a Camera has already been connected and opened. By default, “SegmentsPerBuffer” value is 1 which means that software indication signal will occur on every frame/line captured. To modify and achieve the mentioned functionality the following steps should be taken:

1. Scan and connect to a chosen Camera.
2. “SegmentsPerBuffer” is a grabber parameter subordinate to connected camera. Use the `KYFG_SetGrabberValue` (or one of its sub-functions) with `CAMHANDLE` to set the parameter value.

NOTE: *For more information on grabber parameters under “CameraSelector” refer to section 8.1. Note that buffer allocation is directly affected by this operation!*

10.1.4 Frames per stream

The “FramesPerStream” parameter defines the number of frames to be allocated for stream's memory buffer (max. 65535). In case “KYFG_StreamCreateAndAlloc()” function is used with “frames” parameter value as 0. This accommodates in configuration of the number of frames to be allocated for stream, externally of function call.

10.1.5 Bayer de-mosaic

A Bayer filter mosaic is a color filter array (CFA) for arranging RGB color filters on a square grid of photo sensors. Its particular arrangement of color filters is used in most single-chip digital image sensors used in digital cameras, camcorders, and scanners to create a color image. The Bayer filter has twice green pixels then red or blue ones because human's eye is more sensitive to green light. The filter pattern is 50% green, 25% red and 25% blue, hence is also called RGBG, GRGB, BGGR or RGGB. The example structure of the CFA can be seen in Figure 13.

As each pixel in the array contains only one color plane, the de-mosaicking algorithm should calculate the missing color pixels at each particular position. To enable the de-mosaic format transformation, set the "PixelFormat" parameter value to "RGB8". **Note that buffer allocation is directly affected by this operation!**

Two different de-mosaicking algorithms are available dependent on the line scan or area scan sensor.

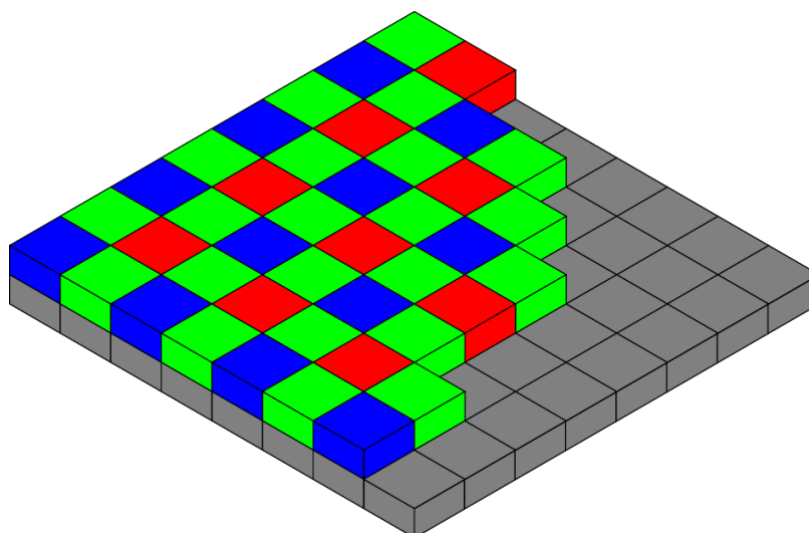

Figure 13 – Bayer filter example

10.1.5.1 Bilinear de-mosaicking (Area scan)

The bilinear de-mosaicking algorithm performs the color reconstruction for each pixel by interpolation in a 3-by-3 pixel neighborhood. The interpolation kernel differs for even/odd rows/columns and is according to the Figures shown below. The calculations are performed with full 16bits resolution.

G0	B1	G2
R3	G4	R5
G6	B7	G8

$$R4' = \frac{(R3 + R5)}{2}$$

$$G4' = G4$$

$$B4' = \frac{B1 + B7}{2}$$

B0	G1	B2
G3	R4	G5
B6	G7	B8

$$R4' = R4$$

$$G4' = \frac{G1 + G3 + G5 + G7}{4}$$

$$B4' = \frac{B0 + B2 + B6 + B8}{4}$$

R0	G1	R2
G3	B4	G5
R6	G7	R8

$$R4' = \frac{R0 + R2 + R6 + R8}{4}$$

$$G4' = \frac{G1 + G3 + G5 + G7}{4}$$

$$B4' = B4$$

G0	R1	G2
B3	G4	B5
G6	R7	G8

$$R4' = \frac{R1 + R7}{2}$$

$$G4' = G3$$

$$B4' = \frac{B3 + B5}{2}$$

Figure 14 – Bilinear de-mosaicking algorithm (Area scan)

10.1.5.2 Gradient corrected bilinear de-mosaicking (Line scan)

For line-scan cameras with Bayer filter a special gradient corrected reconstruction is used. The reconstruction forms a single image line out of two lines acquired from camera sensor. The reconstruction uses a gradient corrected interpolation in a 3-by-2 pixel neighborhood.

The interpolation kernel differs for even/odd columns and is according to the Figures shown below. The calculations are performed with full 16 bits resolution.



$$R1' = \frac{R0 + R2}{2} + G1 - \frac{G3 + G5}{2}$$

$$G1' = G1$$

$$B1' = B4$$



$$R1' = R1$$

$$G1' = G4$$

$$B1' = \frac{B3 + B5}{2} + G4 - \frac{G0 + G2}{2}$$

Figure 15 – Bilinear de-mosaicking algorithm (Line scan)

10.1.6 Data Packing Mode

Data packing reduces unpacked data padding overhead, thus increasing transfer rates without losing data. Different data packing bitnesses layouts are described as follows:

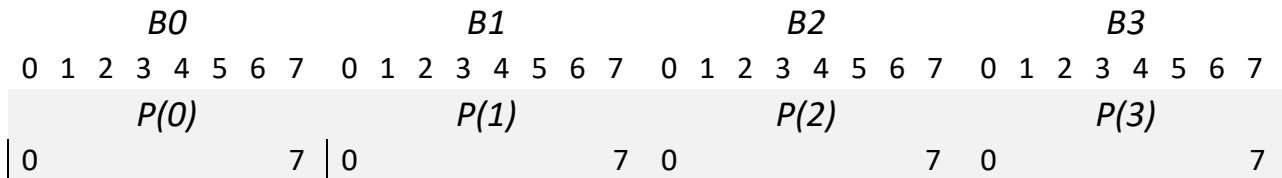

Figure 16 – Packing of 8 bit pixels

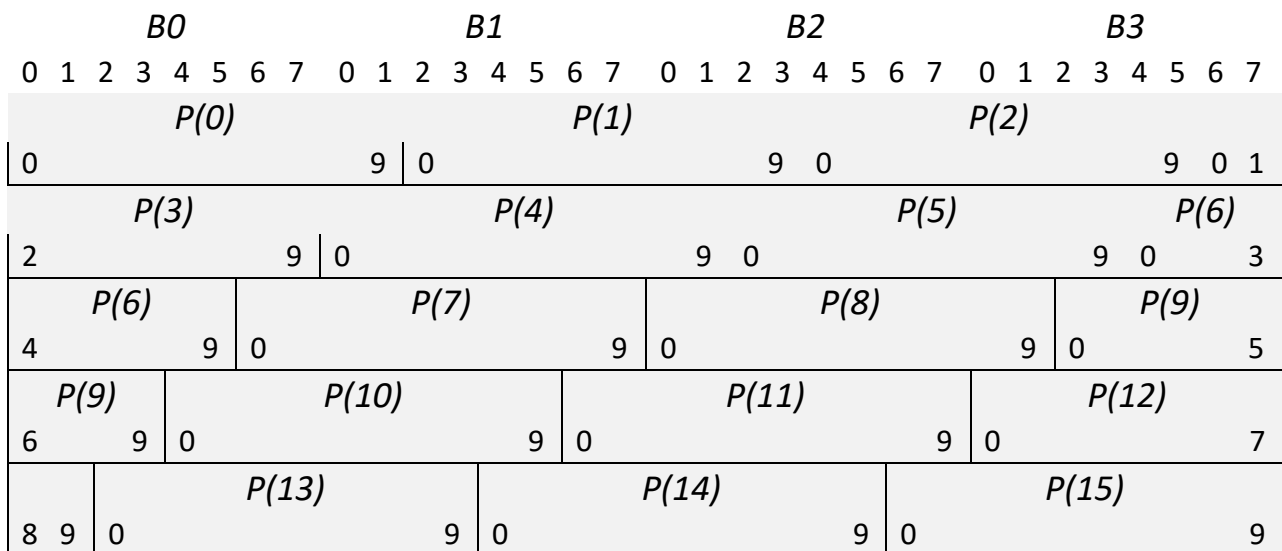

Figure 17 – Packing of 10 bit pixels

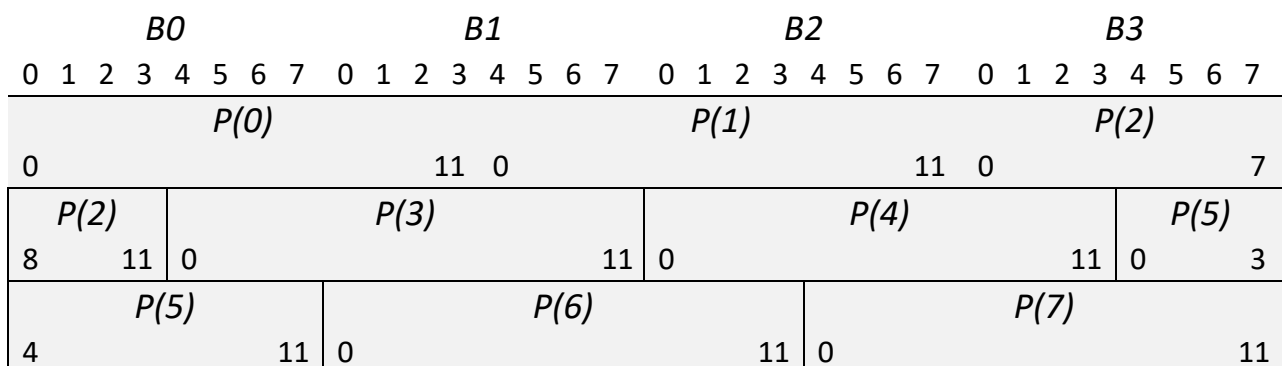

Figure 18 – Packing of 12 bit pixels

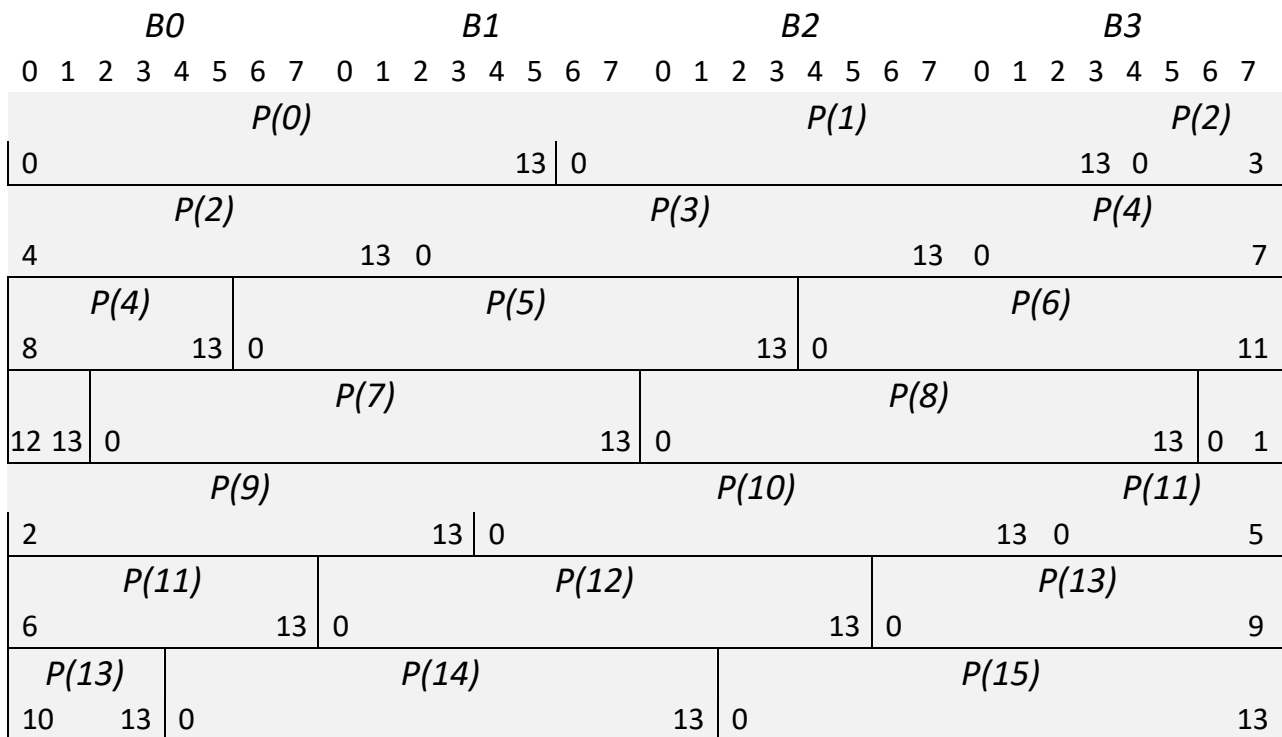

Figure 19 – Packing of 14 bit pixels

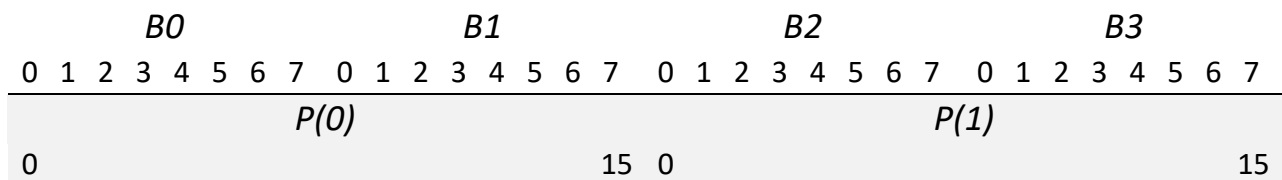

Figure 20 – Packing of 16 bit pixels

By default, stream output will be Unpacked, meaning 10, 12 and 14 bit data will be padded and fit into 2 bytes for each pixel channel. To achieve data packing, "PackedDataMode" should be configured to "Packed_RowAligned32" mode. This will allow to preserve originally packed data or pack an unpacked data stream.

The output stream will be modified as such, that every line will be padded at its end, so byte count will be 32bit aligned. Such approach will accommodate in line manipulation and sequencing.

10.2 Color transformation

The color transformation can be used for color correction operators such as adjusting white balance, color transformation, brightness or contrast. The Color Transformation is a linear operation taking as input a triplet of Components (C0, C1, C2) for a color pixel (Typically: Rin, Gin, Bin representing a RGB color pixel). This triplet is first multiplied by a 3x3 matrix and then added to an offset triplet. The equation is given in the following form:

$$\begin{pmatrix} C0out \\ C1out \\ C2out \end{pmatrix} = \begin{pmatrix} Gain00 & Gain01 & Gain02 \\ Gain10 & Gain11 & Gain12 \\ Gain20 & Gain21 & Gain22 \end{pmatrix} \begin{pmatrix} C0in \\ C1in \\ C2in \end{pmatrix} + \begin{pmatrix} Offset0 \\ Offset1 \\ Offset2 \end{pmatrix}$$

And in particular to RGB images:

$$\begin{pmatrix} Rout \\ Gout \\ Bout \end{pmatrix} = \begin{pmatrix} RR & RG & RB \\ GR & GG & GB \\ BR & BG & BB \end{pmatrix} \begin{pmatrix} Rin \\ Gin \\ Bin \end{pmatrix} + \begin{pmatrix} Ro \\ Go \\ Bo \end{pmatrix}$$

For example, an RGB to YUV conversion of 8bit data can be achieved by the formula below:

$$\begin{pmatrix} Y \\ U \\ V \end{pmatrix} = \begin{pmatrix} 0.299 & 0.587 & 0.114 \\ -0.147 & -0.289 & 0.436 \\ 0.615 & -0.515 & -0.100 \end{pmatrix} \begin{pmatrix} Rin \\ Gin \\ Bin \end{pmatrix} + \begin{pmatrix} 0 \\ 128 \\ 128 \end{pmatrix}$$

10.2.1 Monochrome image special case

A special case of image transformation is applicable for monochrome images to achieve gain/offset operator. For this case the gain matrix should be set to diagonal gain and offset should be the same for each component as below.

$$\begin{pmatrix} C0out \\ C1out \\ C2out \end{pmatrix} = \begin{pmatrix} Gain & 0 & 0 \\ 0 & Gain & 0 \\ 0 & 0 & Gain \end{pmatrix} \begin{pmatrix} C0in \\ C1in \\ C2in \end{pmatrix} + \begin{pmatrix} Offset \\ Offset \\ Offset \end{pmatrix}$$

The color transformation parameters are described in Table 20.

Parameter	Description	Gen<i>Cam name	Type	Possible values		Remarks
				Value	Gen<i>Cam name	
Gen<i>Cam Category: ExtendedStreamFeatures \ ColorTransformationControl						
Color transformation matrix coef RR	Gain factor of R on Rin channel in color transformation matrix	ColorTransformationRR	Float			
Color transformation matrix coef RG	Gain factor of G on Rin channel in color transformation matrix	ColorTransformationRG	Float			
Color transformation matrix coef RB	Gain factor of B on Rin channel in color transformation matrix	ColorTransformationRB	Float			
Color transformation matrix coef RO	Offset factor of R channel in color transformation matrix	ColorTransformationRO	Float			
Color transformation matrix coef GR	Gain factor of R on Gin channel in color transformation matrix	ColorTransformationGR	Float			
Color transformation matrix coef GG	Gain factor of G on Gin channel in color transformation matrix	ColorTransformationGG	Float			
Color transformation matrix coef GB	Gain factor of B on Gin channel in color transformation matrix	ColorTransformationGB	Float			
Color transformation matrix coef GO	Offset factor of G channel in color transformation matrix	ColorTransformationGO	Float			
Color transformation matrix coef BR	Gain factor of R on Bin channel in color transformation matrix	ColorTransformationBR	Float			
Color transformation matrix coef BG	Gain factor of G on Bin channel in color transformation matrix	ColorTransformationBG	Float			
Color transformation matrix coef BB	Gain factor of B on Bin channel in color transformation matrix	ColorTransformationBB	Float			
Color transformation matrix coef BO	Offset factor of B channel in color transformation matrix	ColorTransformationBO	Float			

Table 20 – Color transformation control parameters

11 I/O Controller

KAYA's Frame Grabber boards include a large array of auxiliary signal which can be used to initiate on-board events, transmitted to other devices or rerouted from other signals, such as CoaXPress triggers and GPIO's. Additionally, these auxiliary signals can be used to communicate with complex devices, such as encoders, strobe controls and drive controls.

The GPIOs can be configured and controlled from the provided API and be set as a trigger sources. The API enables routing of any input to any output as well as to the CoaXPress IO and Trigger lines. The I/O controller is responsible for the following features:

- Triggers
- I/O lines
- Encoders
- Timers

The provided trigger can be divided into two main groups: Camera triggers and Frame Grabber triggers.

11.1 Camera Trigger

The Camera triggers are issued per camera through the camera CoaXPRESS channels. Camera logic intercepts the signal and performs according to preconfigured camera setting, such as 1 frame transmission for example. A sequence of synchronous or asynchronous signals can be configured to be issued for selected camera. Such configuration can be useful in configuring event controlled image acquisition. The flow of the camera trigger signal can be seen in Figure 21.

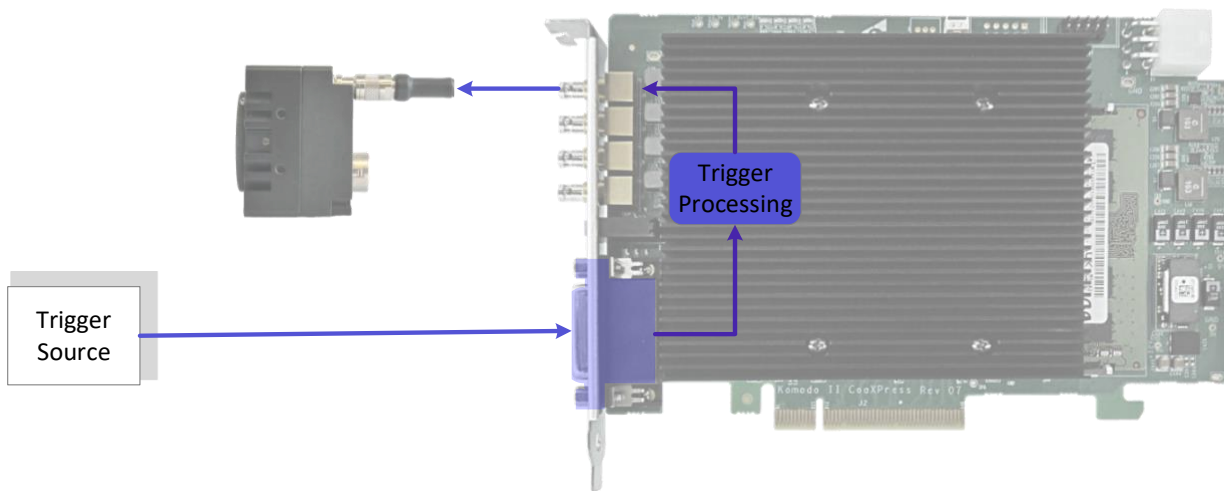

Figure 21 – Camera trigger source

Triggers' origin can be selected from number of sources such as encoders, I/O lines and timers. Additional properties are available for better capturing and processing trigger signals (To configure camera trigger mode please refer to camera manufacturer manual). The structure of the camera trigger is described in Figure 22.

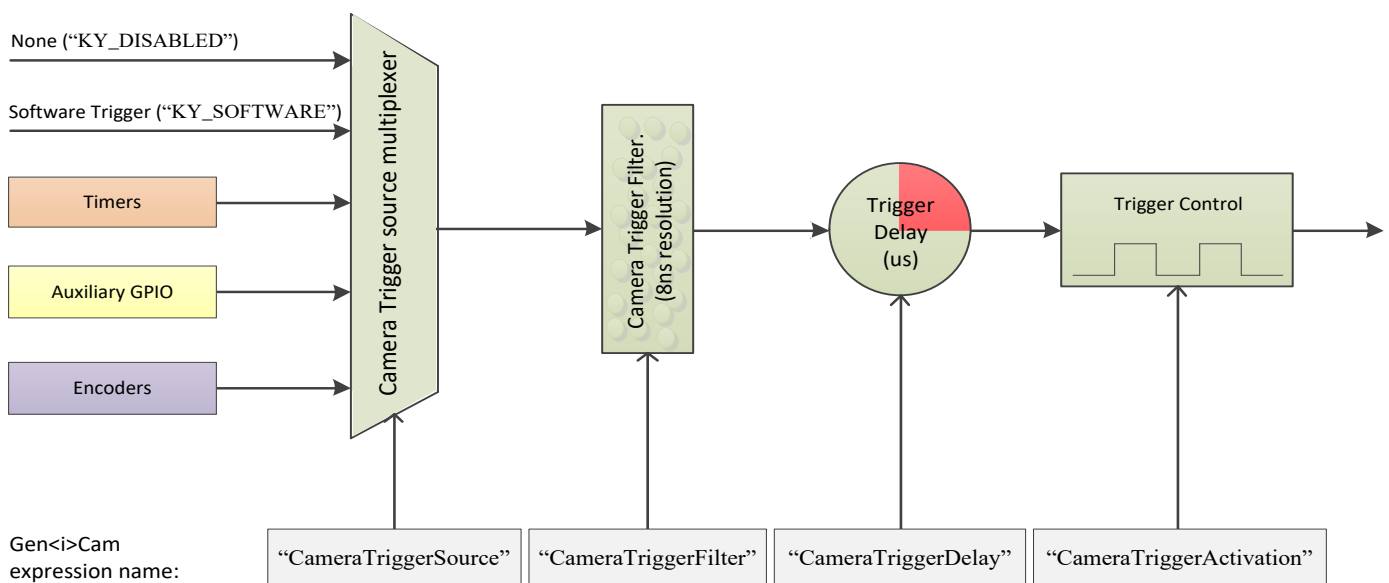

Figure 22 – Camera trigger structure

The parameters of the camera trigger are described in Table 21.

Parameter	Description	Gen<i>Cam name	Type	Possible values		Remarks
				Value	Gen<i>Cam name	
Gen<i>Cam Category: ExtendedStreamFeatures \ CameraTriggerControl						
Camera Trigger Mode	Controls if the trigger is active	CameraTriggerMode [CameraSelector]	Enumeration	0 1	Off On	
Camera Trigger Software	Generates an internal trigger	CameraTriggerSoftware [CameraSelector]	Command	1 – Activate		To issue command “CameraTriggerSource” must be set to “Software”
Camera Trigger Activation	Activation mode of the trigger in respect to the input	CameraTriggerActivation [CameraSelector]	Enumeration	0 1 2 3 4 5	RisingEdge FallingEdge AnyEdge RisingEdgeInv FallingEdgeInv AnyEdgeInv	Inv means inverted. Only Selected edge CXP packet will be issued to the camera.
Camera Trigger Source	Source I/O	CameraTriggerSource [CameraSelector]	Enumeration			See section 0 Trigger Source options
Camera Trigger Delay	Delay before issuing trigger	CameraTriggerDelay [CameraSelector]	Integer			In units of microseconds (us)
Camera Trigger Filter	Filter for Frame Grabber trigger	CameraTriggerFilter [CameraSelector]	Float			In units of microseconds (us) 8ns resolution using fraction value
Camera Trigger Event Enable	Enables event generation for camera trigger	CameraTriggerEventEnable [CameraSelector]	Enumeration	0 1	Disable Enable	Will generate software even for any trigger

Table 21 – Camera Trigger parameters

11.1.1 Camera Trigger activation mode

The trigger activation mode configures the capture criteria of signal state. Default value is Rising Edge, which will issue a trigger on signal rising edge event. The different modes functionality is as follows:

1. Any Edge: A rising edge of the selected trigger source generates rising edge trigger packets, and a falling edge generates falling edge packets. This allows e.g. camera exposure to be controlled by the time between the rising and falling edges, as well as one of the edges providing the trigger.
2. Rising Edge: A rising edge of the selected trigger source generates rising edge trigger packets, and a falling edge is ignored. This allows a higher trigger rate but does not allow exposure control independent from the trigger rate.
3. Falling Edge: A falling edge of the selected trigger source generates falling edge trigger packets, and a rising edge is ignored.
4. Inverted: This mode can be applied to any of the above, and results in a rising edge generating a falling edge trigger packet, and a falling edge to generate a rising edge trigger packet.

11.1.2 Camera Trigger signals filter

The filter of the trigger signals acts as a de-bouncing mechanism for better handling generated noise. By default the filter is disabled with the value of 0. The signal filter resolution can be set at 8ns intervals for high resolution functionality. If the trigger filter is set to a larger value than the width of the trigger pulse, then the pulse will be filtered out and no trigger will occur. Available interface in API provides input in microsecond; nevertheless, to achieve higher resolution, relevant fraction values should be entered after the decimal point.

11.1.3 Camera Trigger Delay

The trigger delay is a mechanism for postponing the incoming signal for a specified number of microseconds. As a result, trigger will be issued after specified time delay to overcome known system latency. To disable, value 0 should be set.

11.1.4 Camera Trigger Event

Camera trigger event may be enabled for selected camera. This will generate event callback whenever such trigger is generated in hardware. Steps to enable and use such event mechanism are as follows:

1. “CameraTriggerEventEnable” is a grabber parameter subordinate to connected camera. Use the KYFG_SetGrabberValue (or one of its sub-functions) with CAMHANDLE to set the parameter value to “Enable”.
2. Note: For more information on grabber parameters under “CameraSelector” refer to section 8.1.
3. Register a callback function for Auxiliary events using KYFG_AuxDataCallbackRegister() function.
4. To extract the data attached to such event KYFG_BufferGetAux() function with KYFG_IO_AUX_DATA structure should be used.

11.1.5 Steps to properly configure Camera Triggers

1. “CameraTriggerMode” is a grabber parameter subordinate to connected camera. Use the KYFG_SetGrabberValue (or one of its sub-functions) with CAMHANDLE to set the parameter value to “On”.

NOTE: For more information on grabber parameters under “CameraSelector” refer to section 8.1.

2. The trigger source should be selected according to provided sources and available card GPIO. Only one source can be active, for each camera, at any time.
3. The Trigger Filter resolution (“CameraTriggerDelay”), Activation Mode (“CameraTriggerActivation”) and Trigger Delay (“CameraTriggerDelay”) parameters should be configured according to desired output.
4. In some cases, the trigger sources should also be configured via provided API before trigger configuration is complete. (e.g if “KY_TIMER_ACTIVE_0” is to be selected as Camera Trigger source, then “Timer0” should first be configured as described in Timer Block configuration in this chapter).
5. Configure the camera to be in trigger mode, in order to allow triggered control through the Frame Grabber.

NOTE: To configure camera trigger mode please refer to camera manufacturer manual.

11.2 Acquisition (Frame Grabber) Triggers

The Acquisition (Frame Grabber) triggers are stream oriented; these are issued through internal logic while the system is in data acquisition mode. When configured in this mode, the camera will always stream the images, while Frame Grabber will select which images it should receive based on Acquisition trigger. The flow of the trigger signal in this mode is described in Figure 23.

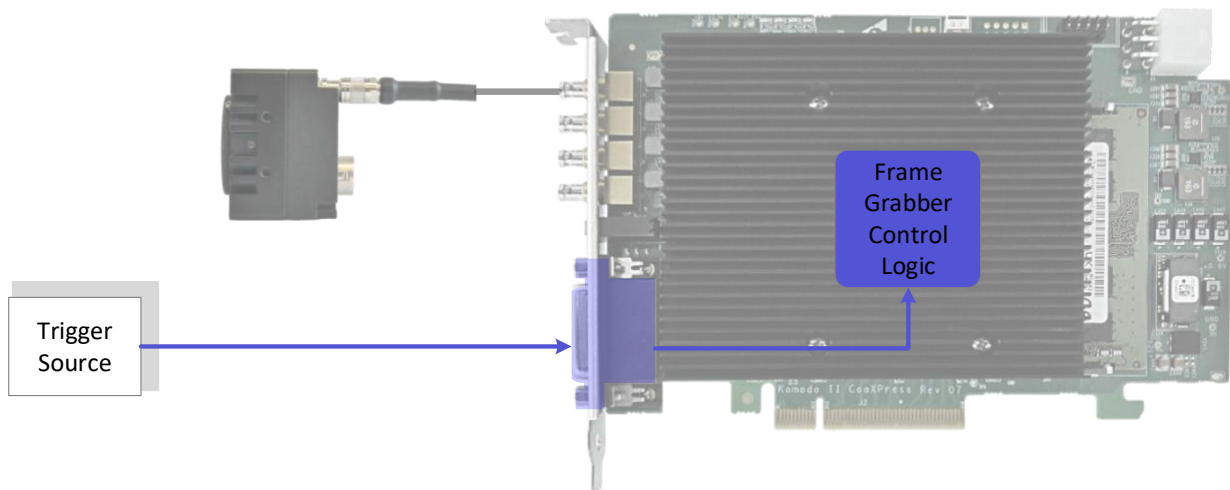

Figure 23 – Acquisition stream trigger source

Internal or external signals/events can act as a source for these triggers. Certain cameras can also be configured to issue triggers for the Frame Grabber over the relevant CoaXPress channel. In some cases both Camera triggers and Frame Grabber triggers can be used simultaneously to achieve desired effect. Also, a signal can be configured to perform as a trigger for other signals which consequently will be the trigger for Frame Grabber or Camera. The structure of the Acquisition trigger mechanism is described in Figure 24.

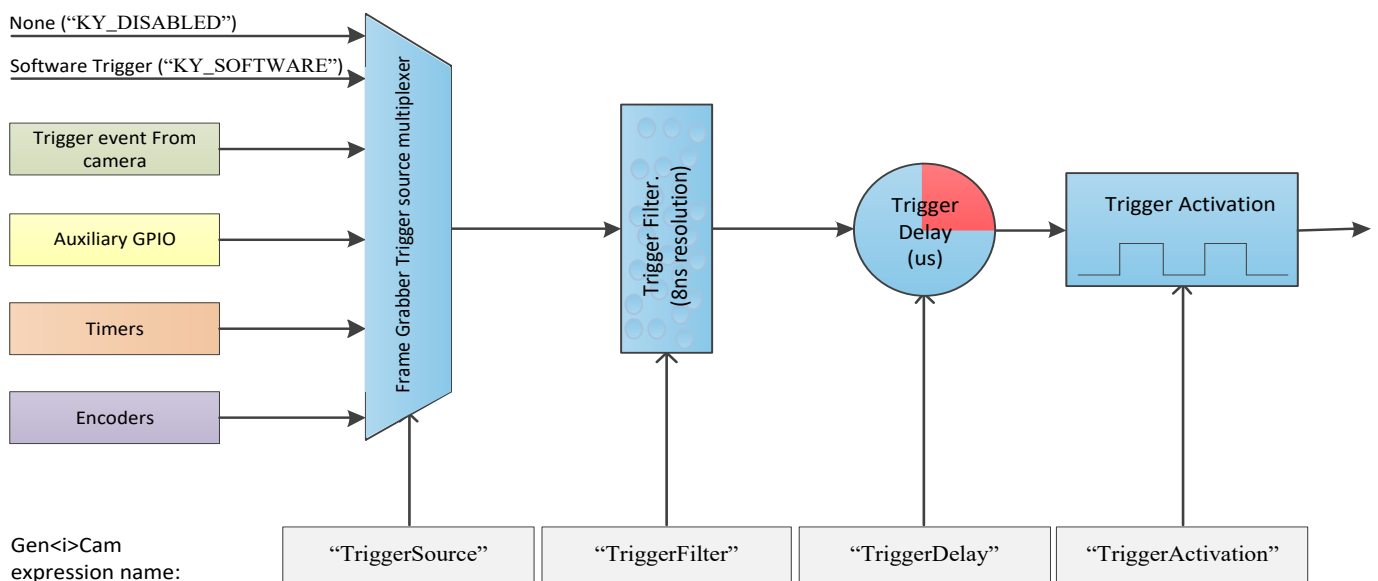

Figure 24 – Acquisition stream trigger structure

The parameters of the acquisition triggers are described in Table 22.

Parameter	Description	Gen<i>Cam name	Type	Possible values		Remarks
				Value	Gen<i>Cam name	
Gen<i>Cam Category: FrameGrabberIOControl \ TriggerControl						
Trigger Mode	Controls if the trigger is active	TriggerMode [CameraSelector]	Enumeration	0 1	Off On	
Trigger Software	Generates an internal trigger	TriggerSoftware [CameraSelector]	Command	1 - Activate		To issue command "TriggerSource" must be set to "Software"
Trigger Activation	Activation mode of the trigger to issue trigger	TriggerActivation [CameraSelector]	Enumeration	0 1 2 3 4	RisingEdge FallingEdge AnyEdge LevelHigh LevelLow	
Trigger Source	Source I/O	TriggerSource [CameraSelector]	Enumeration			See section 0 Trigger Source options
Trigger Delay	Delay before issuing trigger	TriggerDelay [CameraSelector]	Integer			In units of microseconds (us)
Trigger Filter	Filter for Frame Grabber trigger	TriggerFilter [CameraSelector]	Float			In units of microseconds (us) 8ns resolution using fraction value
Trigger Event Mode	Select the condition when to generate software event for acquisition trigger	TriggerEventMode [CameraSelector]	Enumeration	0 1 2 3	Disabled RisingEdge FallingEdge AnyEdge	
Acquisition Burst Frame Count	Specifies the number of frames to acquire for each stream acquisition trigger	AcquisitionBurstFrameCount	Integer			

Table 22 – Acquisition Triggers parameters

11.2.1 Trigger activation mode

The trigger activation mode configures the capture criteria of signal state. Default value is Rising Edge, which will trigger a frame on signal rising edge event. The different modes functionality is as follows:

6. Any Edge: The frames will be acquired both on rising and falling edges of the trigger source.
7. Rising Edge: The frames will be acquired only on rising edge of the trigger source. Falling edge of the source is ignored.
8. Falling Edge: The frames will be acquired only on falling edge of the trigger source. Rising edge of the source is ignored.
9. Level High: High signal level enables a continuous image acquisition, Low signal level will halt the trigger generation.
10. Level Low: Low signal level enables a continuous image acquisition, High signal level will halt the trigger generation.

11.2.2 Trigger signals filter

The filter of the trigger signals acts as a de-bouncing mechanism for better noise immunity. By default, the filter is disabled with the value of 0. The signal filter resolution can be set at 8ns intervals for high resolution functionality. If the trigger filter is set to a larger value than the width of the trigger pulse, then the pulse will be filtered out and no trigger will occur. Available interface in API provides input in microsecond; nevertheless, to achieve higher resolution, relevant fraction values should be entered after the decimal point.

11.2.3 Trigger Delay

The trigger delay is a mechanism for postponing the incoming signal for a specified number of microseconds. As a result, trigger will be issued after specified time delay to overcome known system latency or set trigger generation period. To disable, value 0 should be set.

11.2.4 Trigger Event

Acquisition trigger event may be enabled for selected camera. This will generate event callback whenever such trigger is generated in hardware. Steps to enable and use such event mechanism are as follows:

1. "TriggerEventMode" is a grabber parameter subordinate to connected camera. Use the KYFG_SetGrabberValue (or one of its sub-functions) with CAMHANDLE to set the parameter value to "RisingEdge" for example.

NOTE: For more information on grabber parameters under "CameraSelector" refer to section 8.1.

2. Register a callback function for Auxiliary events using KYFG_AuxDataCallbackRegister() function.
3. To extract the data attached to such event KYFG_BufferGetAux()function with KYFG_IO_AUX_DATA structure should be used.

11.2.5 Steps to properly configure Frame Grabber Triggers

1. “TriggerMode” is a grabber parameter subordinate to connected camera. Use the `KYFG_SetGrabberValue` (or one of its sub-functions) with `CAMHANDLE` to set the parameter value to “On”.

NOTE: For more information on grabber parameters under “CameraSelector” refer to section 8.1.

2. The trigger source should be selected according to provided sources and available card GPIO. Only one source can be active, for each camera, at any time.
3. The Trigger Filter resolution (“TriggerFilter”), Activation Mode (“TriggerActivation”) and Trigger Delay (“TriggerDelay”) parameters should be configured according to desired output.
4. In some cases, the trigger sources should also be configured via provided API before trigger configuration is complete. (e.g if “KY_TIMER_ACTIVE_0” is to be selected as Camera Trigger source, then “Timer0” should first be configured as described in Timer Block configuration in this chapter).
5. After all configurations are complete, start the acquisition. At this point acquisition mechanism will wait for trigger, and Frame Grabber will acquire data upon trigger arrival.

11.3 Encoder trigger functionality

Parameter	Description	Gen<i>Cam name	Type	Possible values		Remarks
				Value	Gen<i>Cam name	
Gen<i>Cam Category: FrameGrabberIOControl \ EncoderControl						
Encoder Selector	Selects Encoder Output signal behavior	EncoderSelector [EncoderSelector]	Enumeration (Selector)			See Table 24
Encoder Output Mode	Selects Encoder Output signal behavior	EncoderOutputMode [EncoderSelector]	Enumeration	0 1 2 3 4	Disabled Position Anystep Stepforward Stepbackward	
Encoder Inverter	Controls the signal inversion	EncoderInverter [EncoderSelector]	Boolean	0 1	False True	
Encoder Position	Encoder value in step counts	EncoderValue [EncoderSelector]	Integer			Writing this register will pre-set the count
Encoder Position Trigger	The value to compare with the Encoder Position Value	EncoderPositionTrigger [EncoderSelector]	Integer			Only used if "EncoderOutputMode" is set to "Position"
Encoder Filter	Filter for encoder signals	EncoderFilter [EncoderSelector]	Float			In units of microseconds (us) 8ns resolution using fraction value
Encoder Reset	Software reset for encoder	EncoderReset [EncoderSelector]	Command	1 - Activate		
Encoder Value at Reset	Last position counter before encoder rest	EncoderValueAtReset [EncoderSelector]	Integer			
Encoder Reset Activation	Activation mode of encoder reset signal	EncoderResetActivation [EncoderSelector]	Enumeration	0 1 2 3 4	RisingEdge FallingEdge AnyEdge LevelHigh LevelLow	
Encoder Reset Source	Source I/O for encoder reset	EncoderResetSource [EncoderSelector]	Enumeration			See section 0 Trigger Source options
Encoder A Source	Source I/O A	EncoderASource [EncoderSelector]	Enumeration			See section 0 Trigger Source options
Encoder B Source	Source I/O B	EncoderBSource [EncoderSelector]	Enumeration			See section 0 Trigger Source options
Encoder Event Enable	Enables event generation for encoder	EncoderEventEnable [EncoderSelector]	Enumeration	0 1	Disable Enable	

Table 23 – Available configurations for Encoders

Value	Output	Gen<i>Cam parameter name
0	Encoder 0	Encoder0
1	Encoder 1	Encoder1
2	Encoder 2	Encoder2
3	Encoder 3	Encoder3

Table 24 – Encoder selection options

Configurable encoder triggers for both Shaft encoders and Quadrature Shaft encoders. Usually used to overcome image capture synchronization issues, by adjusting and controlling image acquisition using encoder physical steps rather than timed capture.

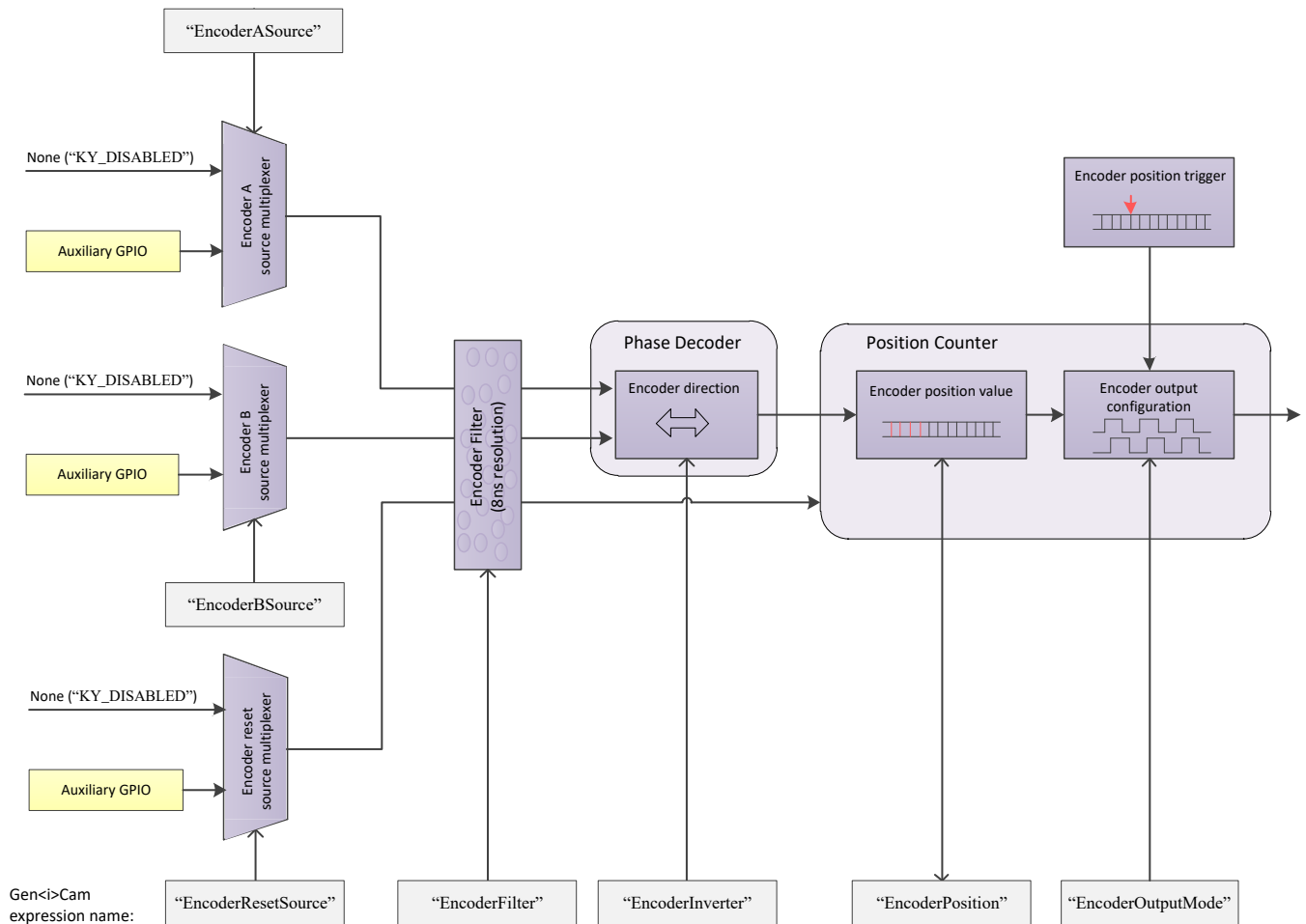

Figure 25 – Encoder triggers structure

While simple shaft encoders have one output, generating pulses according to step resolution, a quadrature shaft encoder has two outputs, called "A" and "B", which are 90° out of phase. This allows interpreting the output of both lines to determine the direction of the encoder.

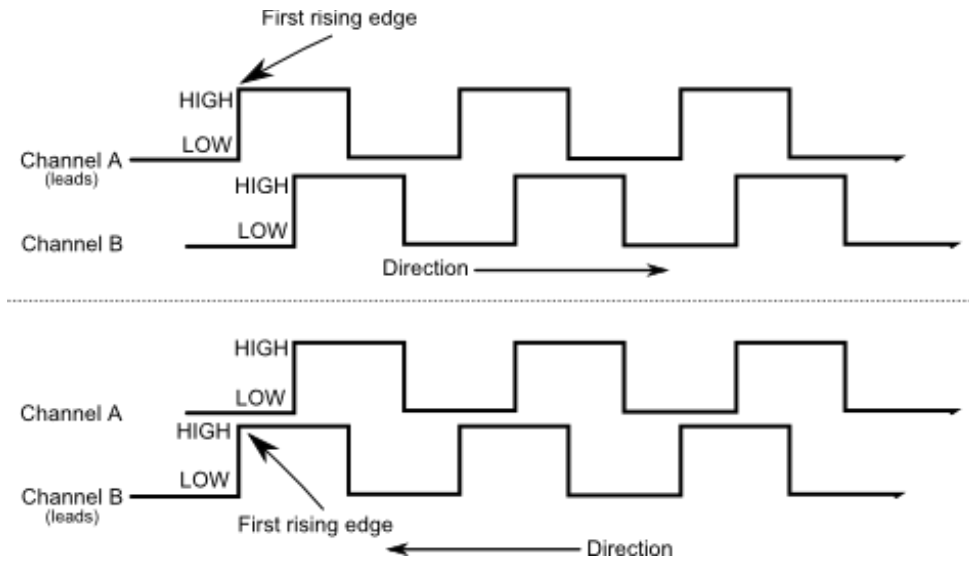

Figure 26 – Encoder channels

11.3.1 Encoder trigger filter

The filter of the trigger signals acts as a de-bouncing mechanism for better handling generated noise. By default, the filter is disabled with the value of 0. The signal filter resolution can be set at 8ns intervals for high resolution functionality. If the trigger filter is set to a larger value than the width of the trigger pulse, then the pulse will be filtered out and no trigger will occur. Available interface in API provides input in microsecond; nevertheless, to achieve higher resolution, relevant fraction values should be entered after the decimal point.

11.3.2 Encoder position and position trigger

Encoder Position defines the current encoder position while the Position Trigger defines the value which encoder step count should reach to issue the trigger. Writing to these registers will pre-set the count. The encoder step counter depends on encoder resolution and is not bound by time limit.

11.3.3 Encoder output mode

The encoder activation mode configures the capture criteria of trigger generation, according to encoder position and direction. Encoder direction output can be inverted, to define a downwards stepper. The different modes functionality is as follows:

1. Disabled: Signal pulse generation is disabled.
2. Position: Signal pulse generation will occur when value of Encoder Position will match the value of Position Trigger.
3. Any step: Signal pulse generation on every encoder step, regardless of encoder direction.
4. Step forward: Signal pulse generation every forward encoder step, backward step is ignored.
5. Step backward: Signal pulse generation every backward encoder step, forward step is ignored.

11.3.4 Encoder Event

Encode event may be enabled for selected encoder. This will generate event callback whenever such trigger is generated in hardware. Steps to enable and use such event mechanism are as follows:

1. Select encoder by setting the “EncoderSelector” parameter and enable “EncoderEventEnable” for selected encoder.
2. Register a callback function for Auxiliary events using `KYFG_AuxDataCallbackRegister()` function.
3. To extract the data attached to such event `KYFG_BufferGetAux()` function with `KYFG_IO_AUX_DATA` structure should be used.

11.4 Timer trigger signals

Parameter	Description	Gen<i>>Cam name	Type	Possible values		Remarks
				Value	Gen<i>>Cam name	
Gen<i>>Cam Category: FrameGrabberIOControl \ TimerControl						
Timer Selector		TimerSelector	Enumeration (Selector)			See Table 26
Timer Delay	Duration of delay to apply at the reception of a trigger before starting the Timer	TimerDelay [TimerSelector]	Float			In units of microseconds (us)
Timer Duration	Duration of the Timer pulse	TimerDuration [TimerSelector]	Float			In units of microseconds (us)
Timer Output Inverter	Controls the inversion of the timer output signal	TimerOutputInverter [TimerSelector]	Boolean	0 1	False True	
Timer Trigger Software	Generates an internal trigger	TimerTriggerSoftware [TimerSelector]	Command	1 - Activate		To issue this command, the "TimerTriggerSource" parameter must be set to "Software"
Timer Reset	Software reset of the selected timer	TimerReset [TimerSelector]	Command	1 - Activate		
Timer Activation	Activation mode of the timer to start the counter	TimerActivation [TimerSelector]	Enumeration	0 1 2 3 4	RisingEdge FallingEdge AnyEdge LevelHigh LevelLow	
Timer Trigger Source	Source I/O	TimerTriggerSource [TimerSelector]	Enumeration			See section 0 Trigger Source options
Timer Event Mode	Select the condition when the software event will be generated for selected timer	TimerEventMode [TimerSelector]	Enumeration	0 1 2 3	Disabled RisingEdge FallingEdge AnyEdge	

Table 25 – Available configurations for Timers

Value	Output	Gen<i>>Cam parameter name
0	Timer Active 0	Timer0
1	Timer Active 1	Timer1
2	Timer Active 2	Timer2
3	Timer Active 3	Timer3
4	Timer Active 4	Timer4
5	Timer Active 5	Timer5
6	Timer Active 6	Timer6
7	Timer Active 7	Timer7

Table 26 – Timer selection options

Configure an internal timer for timed trigger generation. Incorporate selection of signal edge capture mode, timer signal delay and duration and inverter for timer signal.

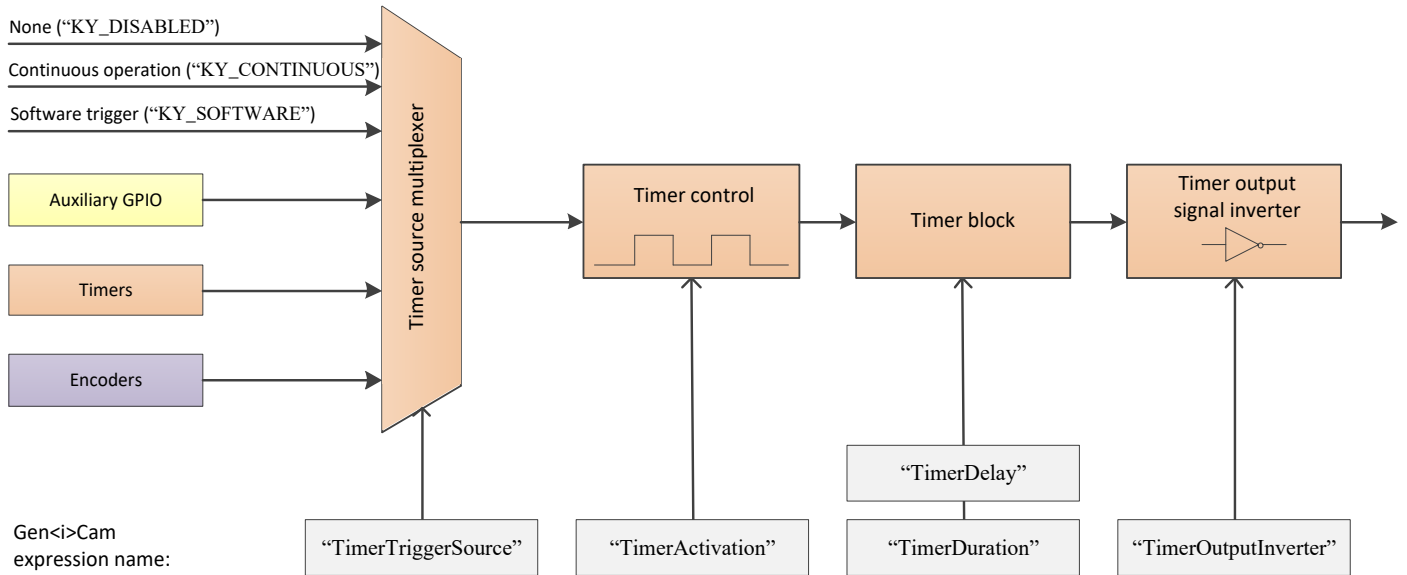

Figure 27 – Timer triggers structure

11.4.1 Timer activation mode

The trigger activation mode configures the capture criteria of signal state. Default value is Rising Edge, which will issue a trigger on signal rising edge event. The different modes functionality is as follows:

1. Any Edge: Any edge of the selected trigger source signal will increment 1 timer count (Duration + Delay time).
2. Rising Edge: A rising edge of the selected trigger source will increment 1 timer count (Duration + Delay time), and a falling edge is ignored.
3. Falling Edge: A falling edge of the selected trigger source will increment 1 timer count (Duration + Delay time), and a rising edge is ignored.
4. Level High: High signal level enables a continuous timer operation. Low signal level will halt the timer.
5. Level Low: Low signal level enables a continuous timer operation. High signal level will halt the timer.

11.4.2 Timer delay, duration and signal inversion

Input value of delay, duration and inversion will determine the timer signal behavior as a rule for timer tick count. Duration will determine the ON position of the timer signal, while delay will determine the OFF position of the signal. The output inverter is responsible for flipping the signal level of duration and delay values.

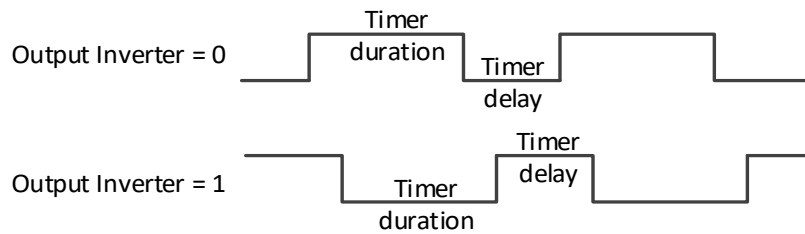

Figure 28 – Output inverters

Timers' counters are in 8ns intervals for high resolution functionality. Available interface in API provides input in microsecond; nevertheless, to achieve higher resolution, relevant fraction values should be entered after the decimal point.

11.4.3 Timer Event

Timer trigger event may be enabled for selected timer. This will generate event callback whenever such trigger is generated in hardware. Steps to enable and use such event mechanism are as follows:

1. Select timer by setting the “TimerSelector” parameter and select signal capture mode using “TimerEventMode” for selected timer.
2. Register a callback function for Auxiliary events using `KYFG_AuxDataCallbackRegister()` function.
3. To extract the data attached to such event `KYFG_BufferGetAux()` function with `KYFG_IO_AUX_DATA` structure should be used.

11.5 Auxiliary GPIO block

Parameter	Description	Gen<i>Cam name	Type	Possible values		Remarks
				Value	Gen<i>Cam name	
Gen<i>Cam Category: FrameGrabberIOControl \ DigitalIOControl						
Line Selector		LineSelector	Enumeration (Selector)			See Table 28
Line Mode	Direction of IO pin	LineMode [LineSelector]	Enumeration	0	Input	
				1	Output	
Line Inverter	Invert the output	LineInverter [LineSelector]	Boolean	0	False	
				1	True	
Line Status	Report state of the line	LineStatus [LineSelector]	Boolean	0	False	
				1	True	
Line Format	Selects the line electrical format	LineFormat [LineSelector]	Enumeration	0	NoConnect	
				1	TriState	
				2	TTL	
				3	LVDS	
				4	RS422	
				5	OptoCoupled	
				6	LVTTTL	
7	NonAvailable					
Line Source	Source I/O	LineSource [LineSelector]	Enumeration			See section 0 Trigger Source options
Line Event Mode	Selects condition when event for selected IO line will be generated by software	LineEventMode [LineSelector]	Enumeration	0	Disabled	
				1	RisingEdge	
				2	FallingEdge	
				3	AnyEdge	
Line Status for all inputs	Status of all IO lines	LineStatusAll	Integer			Value for all lines, not effected by line selector value

Table 27 – Available configurations for Input I/O

Value	Output	Gen<i>Cam parameter name
0	OptoCoupled Input 0	KY_OPTO_IN_0
1	OptoCoupled Input 1	KY_OPTO_IN_1
2	OptoCoupled Input 2	KY_OPTO_IN_2
3	OptoCoupled Input 3	KY_OPTO_IN_3
4	OptoCoupled Input 4	KY_OPTO_IN_4
5	OptoCoupled Input 5	KY_OPTO_IN_5
6	OptoCoupled Input 6	KY_OPTO_IN_6
7	OptoCoupled Input 7	KY_OPTO_IN_7
8	LVDS Input 0	KY_LVDS_IN_0
9	LVDS Input 1	KY_LVDS_IN_1
10	LVDS Input 2	KY_LVDS_IN_2
11	LVDS Input 3	KY_LVDS_IN_3
12	TTL 0	KY_TTL_0
13	TTL 1	KY_TTL_1
14	TTL 2	KY_TTL_2

15	TTL 3	KY_TTL_3
16	TTL 4	KY_TTL_4
17	TTL 5	KY_TTL_5
18	TTL 6	KY_TTL_6
19	TTL 7	KY_TTL_7
20	LVTTTL 0	KY_LVTTTL_0
21	LVTTTL 1	KY_LVTTTL_1
22	LVTTTL 2	KY_LVTTTL_2
23	LVTTTL 3	KY_LVTTTL_3
24	LVTTTL 4	KY_LVTTTL_4
25	LVTTTL 5	KY_LVTTTL_5
26	LVTTTL 6	KY_LVTTTL_6
27	LVTTTL 7	KY_LVTTTL_7
28	OptoCoupled Output 0	KY_OPTO_OUT_0
29	OptoCoupled Output 1	KY_OPTO_OUT_1
30	OptoCoupled Output 2	KY_OPTO_OUT_2
31	OptoCoupled Output 3	KY_OPTO_OUT_3
32	OptoCoupled Output 4	KY_OPTO_OUT_4
33	OptoCoupled Output 5	KY_OPTO_OUT_5
34	OptoCoupled Output 6	KY_OPTO_OUT_6
35	OptoCoupled Output 7	KY_OPTO_OUT_7
36	LVDS Output 0	KY_LVDS_OUT_0
37	LVDS Output 1	KY_LVDS_OUT_1
38	LVDS Output 2	KY_LVDS_OUT_2
39	LVDS Output 3	KY_LVDS_OUT_3

Table 28 – Line selection options

Large array of GPIO is available for configuring trigger source from external signal generators, such as TTL, LVDS, LVTTTL and OptoCoupled. The auxiliary GPIO signals can be used to initiate on-board events, transmitted to other devices or rerouted from other signals, such as CoaXPress triggers and other GPIOs.

The GPIOs can be configured from the API and be set as a trigger sources. The API enables routing of any input to any output as well as to the CoaXPress IO and Trigger lines. For complete GPIO pinout, see relevant Frame Grabber specification datasheet.

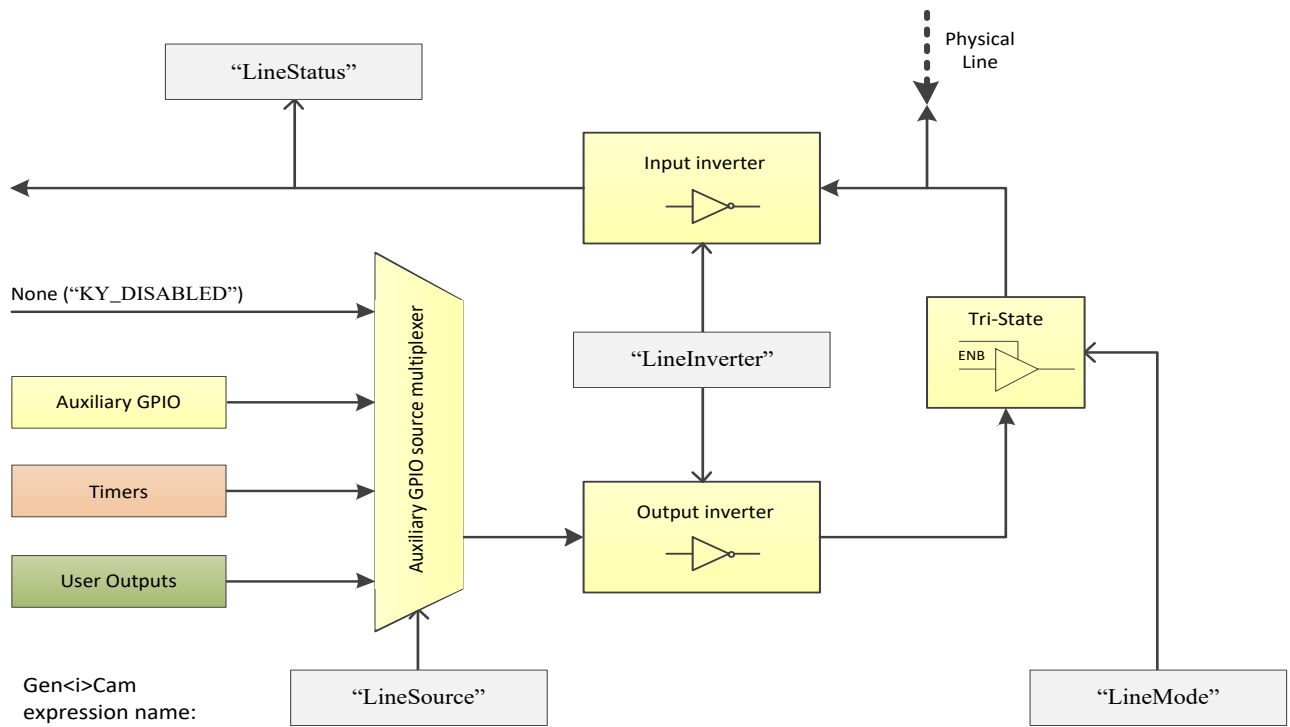

Figure 29 – Digital I/O Line structure

11.5.1 Digital I/O Event

Digital I/O event may be enabled for selected I/O line. This will generate event callback whenever such trigger is generated in hardware. Steps to enable and use such event mechanism are as follows:

1. Select I/O line by setting the “LineSelector” parameter and select signal capture mode using “TimerEventMode” for selected I/O Line.
2. Register a callback function for Auxiliary events using `KYFG_AuxDataCallbackRegister()` function.
3. To extract the data attached to such event `KYFG_BufferGetAux()` function with `KYFG_IO_AUX_DATA` structure should be used.

11.6 User Output block

Parameter	Description	Gen<i>Cam name	Type	Possible values		Remarks
				Value	Gen<i>Cam name	
Gen<i>Cam Category: FrameGrabberIOControl \ DigitalIOControl						
User Output Selector		UserOutputSelector	Enumeration (Selector)			See Table 30
User Output Value	Value of User Output register	UserOutputValue [UserOutputSelector]	Boolean	0 1	False True	
User Output Value All Mask	Set value of all User Output bits	UserOutputValueAll	Integer			Value for all outputs, not effected by selection value
User Output Value All Mask	Bitmask to determine all active outputs	UserOutputValueAllMask	Integer			Value for all outputs, not effected by selection value

Table 29 – Available configurations for User outputs

Value	Output	Gen<i>Cam parameter name
0	User Output 0	UserOutput0
1	User Output 1	UserOutput1
2	User Output 2	UserOutput2
3	User Output 3	UserOutput3
4	User Output 4	UserOutput4
5	User Output 5	UserOutput5
6	User Output 6	UserOutput6
7	User Output 7	UserOutput7

Table 30 – User Output selection options

Software trigger source which can be controlled by user to generate on-board events. User Output can be configured and controlled using provided API. Several User Outputs has been reserved for the purpose of trigger source, their status can be changed in two ways:

1. Individually – setting of “UserOutputValue” parameter value for selected User Output.
2. Group value configuration - configuring value for a group of User Outputs using a combination of “UserOutputValueAll”, which is responsible for set value, and “UserOutputValueAllMask”, which represents bitmask of User Outputs that will be affected.

11.7 Trigger Source options

Enumerated below are available trigger sources for each trigger component. This is subject to device hardware, firmware and software capabilities.

Value	Source	Gen<i>Cam parameter name	I/O	Timer	Trigger	Encoder	Camera Trigger
0	Disabled	KY_DISABLED	✓	✓	✓	✓	✓
1	OptoCoupled Input 0	KY_OPTO_IN_0	✓	✓	✓	✓	✓
2	OptoCoupled Input 1	KY_OPTO_IN_1	✓	✓	✓	✓	✓
3	OptoCoupled Input 2	KY_OPTO_IN_2	✓	✓	✓	✓	✓
4	OptoCoupled Input 3	KY_OPTO_IN_3	✓	✓	✓	✓	✓
5	OptoCoupled Input 4	KY_OPTO_IN_4	✓	✓	✓	✓	✓
6	OptoCoupled Input 5	KY_OPTO_IN_5	✓	✓	✓	✓	✓
7	OptoCoupled Input 6	KY_OPTO_IN_6	✓	✓	✓	✓	✓
8	OptoCoupled Input 7	KY_OPTO_IN_7	✓	✓	✓	✓	✓
9	LVDS Input 0	KY_LVDS_IN_0	✓	✓	✓	✓	✓
10	LVDS Input 1	KY_LVDS_IN_1	✓	✓	✓	✓	✓
11	LVDS Input 2	KY_LVDS_IN_2	✓	✓	✓	✓	✓
12	LVDS Input 3	KY_LVDS_IN_3	✓	✓	✓	✓	✓
13	TTL 0	KY_TTL_0	✓	✓	✓	✓	✓
14	TTL 1	KY_TTL_1	✓	✓	✓	✓	✓
15	TTL 2	KY_TTL_2	✓	✓	✓	✓	✓
16	TTL 3	KY_TTL_3	✓	✓	✓	✓	✓
17	TTL 4	KY_TTL_4	✓	✓	✓	✓	✓
18	TTL 5	KY_TTL_5	✓	✓	✓	✓	✓
19	TTL 6	KY_TTL_6	✓	✓	✓	✓	✓
20	TTL 7	KY_TTL_7	✓	✓	✓	✓	✓
21	LVTTL 0	KY_LVTTL_0	✓	✓	✓	✓	✓
22	LVTTL 1	KY_LVTTL_1	✓	✓	✓	✓	✓
23	LVTTL 2	KY_LVTTL_2	✓	✓	✓	✓	✓
24	LVTTL 3	KY_LVTTL_3	✓	✓	✓	✓	✓
25	LVTTL 4	KY_LVTTL_4	✓	✓	✓	✓	✓
26	LVTTL 5	KY_LVTTL_5	✓	✓	✓	✓	✓
27	LVTTL 6	KY_LVTTL_6	✓	✓	✓	✓	✓
28	LVTTL 7	KY_LVTTL_7	✓	✓	✓	✓	✓
29	OptoCoupled Output 0						
30	OptoCoupled Output 1						
31	OptoCoupled Output 2						
32	OptoCoupled Output 3						
33	OptoCoupled Output 4						
34	OptoCoupled Output 5						
35	OptoCoupled Output 6						
36	OptoCoupled Output 7						
37	LVDS Output 0						
38	LVDS Output 1						
39	LVDS Output 2						
40	LVDS Output 3						
41	Camera Trigger	KY_CAM_TRIG			✓		
42	Continuous	KY_CONTINUOUS		✓			
43	Software	KY_SOFTWARE		✓	✓		✓
44	Encoder 0	KY_ENCODER_0		✓	✓		✓
45	Encoder 1	KY_ENCODER_1		✓	✓		✓
46	Encoder 2	KY_ENCODER_2		✓	✓		✓
47	Encoder 3	KY_ENCODER_3		✓	✓		✓
48	Timer0Active	KY_TIMER_ACTIVE_0	✓	✓	✓		✓
49	Timer1Active	KY_TIMER_ACTIVE_1	✓	✓	✓		✓
50	Timer2Active	KY_TIMER_ACTIVE_2	✓	✓	✓		✓
51	Timer3Active	KY_TIMER_ACTIVE_3	✓	✓	✓		✓

52	Timer4Active	KY_TIMER_ACTIVE_4	✓	✓	✓	✓
53	Timer5Active	KY_TIMER_ACTIVE_5	✓	✓	✓	✓
54	Timer6Active	KY_TIMER_ACTIVE_6	✓	✓	✓	✓
55	Timer7Active	KY_TIMER_ACTIVE_7	✓	✓	✓	✓
56	User Output 0	KY_USER_OUT_0	✓			
57	User Output 1	KY_USER_OUT_1	✓			
58	User Output 2	KY_USER_OUT_2	✓			
59	User Output 3	KY_USER_OUT_3	✓			
60	User Output 4	KY_USER_OUT_4	✓			
61	User Output 5	KY_USER_OUT_5	✓			
62	User Output 6	KY_USER_OUT_6	✓			
63	User Output 7	KY_USER_OUT_7	✓			
64	TriggerN 0	TriggerN0	✓	✓	✓	✓
65	TriggerN 1	TriggerN1	✓	✓	✓	✓
66	TriggerN 2	TriggerN2	✓	✓	✓	✓
67	TriggerN 3	TriggerN3	✓	✓	✓	✓
68	TriggerN 4	TriggerN4	✓	✓	✓	✓
69	TriggerN 5	TriggerN5	✓	✓	✓	✓
70	TriggerN 6	TriggerN6	✓	✓	✓	✓
71	TriggerN 7	TriggerN7	✓	✓	✓	✓
72	TriggerN 8	TriggerN8	✓	✓	✓	✓
73	TriggerN 9	TriggerN9	✓	✓	✓	✓
74	TriggerN 10	TriggerN10	✓	✓	✓	✓
75	TriggerN 11	TriggerN11	✓	✓	✓	✓
76	TriggerN 12	TriggerN12	✓	✓	✓	✓
77	TriggerN 13	TriggerN13	✓	✓	✓	✓
78	TriggerN 14	TriggerN14	✓	✓	✓	✓
79	TriggerN 15	TriggerN15	✓	✓	✓	✓

Table 31 – Frame Grabber I/O source

11.8 Trigger Controls Layout in Vision Point App

Camera Trigger Control		
Camera Trigger Mode	Off	<input type="checkbox"/>
Camera Trigger Activation	Rising Edge	<input type="checkbox"/>
Camera Trigger Source	Disabled	<input type="checkbox"/>
Camera Trigger Delay	0	<input type="checkbox"/>
Camera Trigger Filter	0.000000	<input type="checkbox"/>
Camera Trigger Software	Execute	<input type="checkbox"/>
Camera Trigger Event Enable	Disable	<input type="checkbox"/>

Figure 30 – Camera Trigger Layout in Vision Point App

Digital I/O Control		
Line Selector	OptoCoupled Input 0	<input type="checkbox"/>
Line Mode	Input	<input type="checkbox"/>
Line Inverter	<input type="checkbox"/> False	<input type="checkbox"/>
Line Source	Disabled	<input type="checkbox"/>
Line Status	<input type="checkbox"/> False	<input type="checkbox"/>
Line Format	No Connect	<input type="checkbox"/>
Line Event Mode	Disabled	<input type="checkbox"/>
Line Status All	0x0	<input type="checkbox"/>
User Output Selector	User Output 0	<input type="checkbox"/>
User Output Value	<input type="checkbox"/> False	<input type="checkbox"/>
User Output Value All	0x0	<input type="checkbox"/>
User Output Value All Mask	0x0	<input type="checkbox"/>
Trigger Control		
Trigger Mode	Off	<input type="checkbox"/>
Trigger Activation	Rising Edge	<input type="checkbox"/>
Trigger Source	Disabled	<input type="checkbox"/>
Trigger Delay	0	<input type="checkbox"/>
Trigger Filter	0.000000	<input type="checkbox"/>
Trigger Software	Execute	<input type="checkbox"/>
Trigger Event Mode	Disabled	<input type="checkbox"/>
Timer Control		
Timer Selector	Timer 0	<input type="checkbox"/>
Timer Delay	0.000000	<input type="checkbox"/>
Timer Duration	0.000000	<input type="checkbox"/>
Timer Activation	Rising Edge	<input type="checkbox"/>
Timer Output Inverter	<input type="checkbox"/> False	<input type="checkbox"/>
Timer Trigger Source	Disabled	<input type="checkbox"/>
Timer Trigger Software	Execute	<input type="checkbox"/>
Timer Reset	Execute	<input type="checkbox"/>
Timer Event Mode	Disabled	<input type="checkbox"/>
Encoder Control		
Encoder Selector	Encoder 0	<input type="checkbox"/>
Encoder Output Mode	Disabled	<input type="checkbox"/>
Encoder Inverter	<input type="checkbox"/> False	<input type="checkbox"/>
Encoder A Source	Disabled	<input type="checkbox"/>
Encoder B Source	Disabled	<input type="checkbox"/>
Encoder Position	0	<input type="checkbox"/>
Encoder Position Trigger	0	<input type="checkbox"/>
Encoder Filter	0.000000	<input type="checkbox"/>
Encoder Reset Source	Disabled	<input type="checkbox"/>
Encoder Reset Activation	Rising Edge	<input type="checkbox"/>
Encoder Reset	Execute	<input type="checkbox"/>
Encoder Value at Reset	0	<input type="checkbox"/>
Encoder Event Enable	Disable	<input type="checkbox"/>

Figure 31 – Trigger Layout in Vision Point App

11.8.1 TriggerN Control

According to CoaXPress v2.0 standard some cameras can send triggers to the Frame Grabber in CoaXPress packets. These triggers are received by Frame Grabber and forwarded to other components.

▼ TriggerN Control		
TriggerN Count	16	<input type="checkbox"/>
▼ TriggerN Selector	TriggerN 0	<input type="checkbox"/>
TriggerN Mode	Off	<input type="checkbox"/>
TriggerN Camera Source	0	<input type="checkbox"/>
TriggerN Source	0	<input type="checkbox"/>
TriggerN Event Mode	Off	<input type="checkbox"/>

Figure 32 – TriggerN Control

Parameter	Description	Gen<i>Cam name	Type	Possible values		Remarks
				Value	Gen<i>Cam name	
Gen<i>Cam Category: FrameGrabberIOControl \ TriggerNControl						
TriggerN Count	Maximum number of available TriggerN configurations	TriggerNCount	Integer			
TriggerN Selector	Select the TriggerN configuration to be modified	TriggerNSelector	Enumeration (Selector)			See Error! Reference source not found.
TriggerN Mode	Activate/deactivate the selected TriggerN configuration.	TriggerNMode [TriggerNSelector]	Enumeration	0 1	Off On	
TriggerN Camera Source	Source camera index which the LinkTriggerN trigger will originate from	TriggerNCameraSource [TriggerNSelector]	Integer			
TriggerN Source	The trigger number to pass through by this configuration	TriggerNSource [TriggerNSelector]	Integer	Min: 0 Max: 15		
TriggerN Event Mode	TriggerN Event Mode enable	TriggerNEventMode	Enumeration	0 1	Off On	

Table 32 – Available configurations for TriggerN Control

11.8.1.1 TriggerN mode

Activate/deactivate the selected TriggerN configuration. If active it will pass through only the LinkTriggerN trigger selected by "TriggerNCameraSource" and "TriggerNSource".

11.8.1.2 TriggerN Source

The trigger number, defined by the LinkTriggerN field in the source trigger packet, to pass through by this configuration.

Value	TriggerN	Gen<i>Cam parameter name
0	TriggerN 0	TriggerN0
1	TriggerN 1	TriggerN1
2	TriggerN 2	TriggerN2
3	TriggerN 3	TriggerN3
4	TriggerN 4	TriggerN4
5	TriggerN 5	TriggerN5
6	TriggerN 6	TriggerN6
7	TriggerN 7	TriggerN7
8	TriggerN 8	TriggerN8
9	TriggerN 9	TriggerN9
10	TriggerN 10	TriggerN10
11	TriggerN 11	TriggerN11
12	TriggerN 12	TriggerN12
13	TriggerN 13	TriggerN13
14	TriggerN 14	TriggerN14
15	TriggerN 15	TriggerN15

Table 33 – TriggerN selector

How to configure TriggerN control:

1. Identify the camera index and the high speed trigger number that need to be captured by the Frame Grabber.
2. Select one of the available TriggerN configuration using "TriggerNSelector".
3. Activate the configuration to allow the high speed trigger to pass through using "TriggerNMode" = "On"
4. Set the camera index and the high speed trigger number, defined by the LinkTriggerN field in the source trigger packet, using "TriggerNCameraSource" and "TriggerNSource" respectively.

12 Protocol Specific Features (CoaXPress)

12.1 CoaXPress Connectivity Test

Configuration parameters of Connection Test, using dedicated test pattern packets produced by a sequence generator. As described in JIIA CXP-001-2013 (CoaXPress Standard) document section 8.7 - "Connection Test".

Parameter	Description	Gen<i>Cam name	Type	Possible values		Remarks
				Value	Gen<i>Cam name	
Gen<i>Cam Category: CoaXPress						
CoaXPress connection selector	Selects the CoaXPress physical connection to control	CxpConnectionSelector	Integer (Selector)			FG_MAX_VALUE-1
Connection test mode	Test communication errors of the system cabling between devices	CxpConnectionTestMode [CxpConnectionSelector]	Enumeration	0 1	Off Mode1	Mode1 will enable traffic of connection test packets from Host to Device
Connection Test Error Count	Camera CRC Error Counter. Number of CRC errors generated from corrupted data packets	CxpConnectionTestErrorCount [CxpConnectionSelector]	Integer			
Connection Test RX packets	Reports the current count for test packets received by the device on the connection selected by CxpConnectionSelector	CxpConnectionTestRxPacketCount [CxpConnectionSelector]	Integer (8 bytes)			
Connection Test TX packets	Reports the current count for test packets sent to the device on the connection selected by CxpConnectionSelector	CxpConnectionTestTxPacketCount [CxpConnectionSelector]	Integer (8 bytes)			
CXP Heartbeats Throttling	CXP Heartbeats Throttling	CxpHeartbeatsThrottling [CxpConnectionSelector]	Integer			

Table 34 – CoaXPress connection test parameters

12.2 CoaXPress Trigger Statistics

The trigger statistics track output and input trigger signals. The relevant counters increase according to how the trigger signals influence the system.

Parameter	Description	Gen<i>Cam name	Type	Possible values		Remarks
				Value	Gen<i>Cam name	
Gen<i>Cam Category: CoaXPress						
Trigger Missed Count	Missed triggers count. Increases when a trigger arrives from the user, but the system is already busy processing a different trigger.	TriggerMissedCount [CxpConnectionSelector]	Integer			
Trigger Sent Count	Sent triggers count. Increases when a trigger packet is sent from the host IP to remote device.	TriggerSentCount [CxpConnectionSelector]	Integer			
Trigger Acknowledge Count	Acknowledgement triggers count. Increases when an acknowledge arrives from the remote device to the host, for a trigger sent from the host to the remote device.	TriggerAcknowledgeCount [CxpConnectionSelector]	Integer			
Trigger Change Count	In change triggers count. Increases when the user gives a trigger to the host.	TriggerChangeCount [CxpConnectionSelector]	Integer			

Table 35 – CoaXPress trigger counters

13 System Monitor Control

13.1 System Monitor Control

Monitor and configuration of available individual system components, independent of currently connected peripherals. For example: stream channel controls, link connection configurations and monitoring etc.

Parameter	Description	Gen<i>Cam name	Type	Possible values		Remarks
				Value	Gen<i>Cam name	
Gen<i>Cam Category: SystemMonitorControl						
Connection Channel Selector	Selects the connection channel to control	ConnectionChannelSelector	Integer (Selector)			
ConnectionSpeed	Connection speed change	ConnectionSpeed [ConnectionChannelSelector]	Enumeration	0x28	ConnectionSpeedCXP1	
				0x30	ConnectionSpeedCXP2	
				0x38	ConnectionSpeedCXP3	
				0x40	ConnectionSpeedCXP5	
				0x48	ConnectionSpeedCXP6	
				0x50	ConnectionSpeedCXP10	
				0x58	ConnectionSpeedCXP12	
				10	ConnectionSpeedCLHS10	
	12	ConnectionSpeedCLHS12				
	14	ConnectionSpeedCLHS14				
	16	ConnectionSpeedCLHS16				
Stream Channel Selector	Selects the stream channel to control	StreamChannelSelector	Integer (Selector)			
Statistics Counters Reset	Reset all stream statistics counters	StreamStatisticsReset [StreamChannelSelector]	Command	1 - Activate		
RX Packet Counter	Stream RX Packet Counter. Total number of packets received from the camera	StreamRxPackets [StreamChannelSelector]	Integer			
Drop Packet Counter	Camera Drop Packet Counter. Number of packets dropped due to corruption	StreamDropPackets [StreamChannelSelector]	Integer			
RX Frame Counter	RX Frame Counter. Number of received frames from camera	StreamRxFrames [StreamChannelSelector]	Integer			
Drop Frame Counter	Camera Drop Frame Counter. Number of frames dropped due to corruption	StreamDropFrames [StreamChannelSelector]	Integer			

Table 36 – System monitor parameters

14 Replay Control

14.1 Replay Control

Video replay mode controls for Vision Point GUI.

Parameter	Description	Gen<i></i>Cam name	Type	Possible values		Remarks
				Value	Gen<i></i>Cam name	
Gen<i></i>Cam Category: ReplayControl						
Replay Frame Rate	Replay Frame rate in Hz	ReplayFrameRate	Float			In units of Hz

Table 37 – Replay control parameters

15 Protocol Specific Features (CLHS)

15.1 Pulse Message

According to CLHS standard, the Pulse Message's primary use is to cause the camera to perform exposure and send out the video frame(s). KAYA's CLHS compatible Frame Grabber implements the Pulse Message interface for triggering camera's frame acquisition, subject to firmware and software capabilities.

The software model provides two modes of operation, a basic one which can be used to send a Mode1 message upon trigger reception and an advanced one that enables to configure the message that will be sent out. In order to use the extended Pulse Message interface, the "PulseMessageMode" Frame Grabber parameter should be changed to "Advanced". Trigger source, characteristics and Pulse Message fields should be configured in order to generate the required Pulse Message.

Pulse Message fields' description can be found in CLHS official document under the "Pulse Message" section. The Frame Grabber triggering system description can be found in section 0. The Pulse Message control parameters are described in Table 38.

Parameter	Description	Gen<i></i>Cam name	Type	Possible values		Remarks
				Value	Gen<i></i>Cam name	
Gen<i></i>Cam Category: ExtendedStreamFeatures \ PulseMessageSelector						
Pulse Message Mode		PulseMessageMode	Enumeration	0 1	Basic Advanced	Select "Advanced" to activate these features. In "Basic" mode, Pulse Message Mode1 messages will be issued.
Pulse Message Selector	Selected Pulse Message configuration	PulseMessageSelector	Integer	0 - 7		
Pulse Message Enable	Controls if the trigger is active	PulseMessageEnable[PulseMessageSelector]	Enumeration	0 1	Off On	
Pulse Message Software	Generates an internal trigger	PulseMessageSoftware [PulseMessageSelector]	Command	1 - Activate		To issue command "PulseMessageSource" must be set to "Software"
Pulse Message Activation	Activation mode of the trigger in respect to the input.	PulseMessageActivation [PulseMessageSelector]	Enumeration	0 1 2 3 4 5	RisingEdge FallingEdge AnyEdge RisingEdgeInv FallingEdgeInv AnyEdgeInv	Inv means inverted. Only Selected edge packet will be issued to the camera.
Pulse Message Source	Source I/O	PulseMessageSource [PulseMessageSelector]	Enumeration			See section "Trigger Source options" in "KAYA_Frame_Grabber_Programming_Start-up_Guide.pdf" document
Pulse Message Delay	Delay before issuing trigger	PulseMessageDelay [PulseMessageSelector]	Integer			In units of microseconds (us)

Pulse Message Filter	Filter for frame grabber trigger	PulseMessageFilter [PulseMessageSelector]	Float			In units of microseconds (us) 8ns resolution using fraction value
Pulse Message Link Mask Enable	The output physical link mask	PulseMessageLinkMaskEnable[PulseMessageSelector]	Integer			
Pulse Message Pulse Mode	Pulse Mode of generated Pulse Message	PulseMessagePulseMode[PulseMessageSelector]	Enumeration	1 2 3 4 5 6 7	Mode1 Mode2 Mode3 Mode4 Mode5 Mode6 Mode7	According to CLHS Pulse Message specification
Pulse Message Color	Pulse message color select definition	PulseMessageColor [PulseMessageSelector]	Enumeration	0 1 2 3	All Red Blue Green	According to CLHS Pulse Message specification
Pulse Message Pulse Effect	Pulse Message effect intended for synchronous frame by frame control of camera features	PulseMessagePulseEffect [PulseMessageSelector]	Integer			According to CLHS Pulse Message specification
Pulse Message Synchronization Request		PulseMessageSyncRequest [PulseMessageSelector]	Boolean			According to CLHS Pulse Message specification
Pulse Message Frame Period	Pulse Message frame period down counter definition	PulseMessageFramePeriod [PulseMessageSelector]	Integer			According to CLHS Pulse Message specification
Pulse Message Integration Start Red	Pulse Message Red channel integration period down counter definition	PulseMessageIntegrationStartRed[PulseMessageSelector]	Integer			According to CLHS Pulse Message specification
Pulse Message Integration Start Green	Pulse Message Green channel integration period down counter definition	PulseMessageIntegrationStartGreen[PulseMessageSelector]	Integer			According to CLHS Pulse Message specification
Pulse Message Integration Start Blue	Pulse Message Blue channel integration period down counter definition	PulseMessageIntegrationStartBlue[PulseMessageSelector]	Integer			According to CLHS Pulse Message specification

Table 38 – Pulse Message control parameters

15.2 Image Acquisition filter

Image Acquisition Set byte is part of the CLHS stream data header. This byte may be used to convey camera proprietary information about the condition under which the image was acquired. Image Acquisition Set description can be found in CLHS official document under the “Video Data Message” section.

KAYA’s CLHS compatible Frame Grabber implements the Image Acquisition Filter interface, subject to firmware and software capabilities. When enabled, the mechanism controls the filtration of configured Image Acquisition Set values, thus dropping incompatible frames.

The image acquisition filter control parameters are described in the following table.

Parameter	Description	Gen<i>Cam name	Type	Possible values		Remarks
				Value	Gen<i>Cam name	
Gen<i>Cam Category: ExtendedStreamFeatures \ TransportLayerControl						
Image Acquisition Filter Enable	Apply Image Acquisition Filter algorithm	ImageAcquisitionFilterEnable	Boolean	0	False	
				1	True	
Image Acquisition Filter Selector	Condition filter selector, for specific Image Acquisition Set byte value	ImageAcquisitionFilterSelector	Integer	0 - 255		
Image Acquisition Filter Value	Filter(“Disabled”) or allow(“Active”) frame acquisition with the selected condition value	ImageAcquisitionFilterValue [ImageAcquisitionFilterSelector]	Enumeration	0	Disabled	
				1	Active	

Table 39 – Image Acquisition Filter Control

15.3 Link Connection Counters

The link connection counters indicate the low level connection packets sent between the Host and Device, used for link synchronization. In case of missing or unstable connection, the counters will indicate attempts to resynchronize the link.

Parameter	Description	Gen<i>Cam name	Type	Possible values		Remarks
				Value	Gen<i>Cam name	
Gen<i>Cam Category: ExtendedStreamFeatures \ TransportLayerControl						
FEC Received Packets	Received packets by FEC on master link of the device	FEC_RXPackets [CameraSelector]	Integer			
FEC Corrected Packets	Number of corrected packets by FEC on master link of the device	FEC_CorrectedPackets [CameraSelector]	Integer			
FEC Corrupted Packets	Number of uncorrectable packets on master link of the device	FEC_CorruptedPackets [CameraSelector]	Integer			
Revision Packets	Number of Revision packets on master link of the device	RevisionPackets [CameraSelector]	Integer			
Command Packets	Number of Command packets on master link of the device	CommandPackets [CameraSelector]	Integer			

Table 40 – CLHS link connection counters

15.4 Metadata Insertion

When the Metadata insertion feature is activated, some Metadata information will be delivered along or instead to the data stream. The inserted information will be configured according to selected Metadata insertion mode.

15.4.1 Mode1

When the Metadata insertion Mode1 is activated, the first 12 bytes of each image line are replaced by a fixed set of metadata information as follows:

- The logical state of System I/O input lines
- The value of the motion encoder pulse counter
- The value of the Camera Link LVAL pulse counter

Bit	Function
0	OptoCoupled Input 0
1	OptoCoupled Input 1
2	OptoCoupled Input 2
3	OptoCoupled Input 3
4	OptoCoupled Input 4
5	OptoCoupled Input 5
6	OptoCoupled Input 6
7	OptoCoupled Input 7
8	LVDS Input 0
9	LVDS Input 1
10	LVDS Input 2
11	LVDS Input 3
12	TTL 0
13	TTL 1
14	TTL 2
15	TTL 3

Table 41 – System I/O input lines

Format of the metadata for each line in bytes:

3:0	7:4	9:8	11:10	EOL:12
Camera Link LVAL pulse counter (32 bit Little Endian) The counter resets on	Motion encoder 0 pulse counter (32 bit Little Endian)	Logical state of System I/O input lines (16 bit Little Endian)	Reserved	Video raw data

Table 42 – Metadata format

* EOL – End Of Line

The metadata control parameters are described in Table 43.

Parameter	Description	Gen<i>Cam name	Type	Possible values		Remarks
				Value	Gen<i>Cam name	
Gen<i>Cam Category: ExtendedStreamFeatures \ MetaDataControl						
Meta Data Enable Mode	Inserts metadata information according to selected mode	MetaDataMode	Enumeration	0	Disable	
				1	Mode1	

Table 43 – Metadata control parameters

15.5 System Monitor Control

Monitor and control of available connection configurations, of currently connected peripherals.

Parameter	Description	Gen<i>Cam name	Type	Possible values		Remarks
				Value	Gen<i>Cam name	
Gen<i>Cam Category: SystemMonitorControl						
Connection Channel Selector	Selects the connection channel to control	ConnectionChannelSelector	Integer (Selector)			
Connection Counters Reset	Reset all connection counters	ConnectionStatisticsReset [ConnectionChannelSelector]	Integer			
Revision Packets	Number of Revision packets	ConnectionRevisionPackets [ConnectionChannelSelector]	Integer			
Command Packets	Number of Command packets	ConnectionCommandPackets [ConnectionChannelSelector]	Integer			
FEC Received Packets	Received packets by FEC	ConnectionFECRxPackets [ConnectionChannelSelector]	Integer			
FEC Corrected Packets	Number of corrected packets by FEC	ConnectionFECCorrectedPackets [ConnectionChannelSelector]	Integer			
FEC Corrupted Packets	Number of uncorrectable packets	ConnectionFECCorruptedPackets [ConnectionChannelSelector]	Integer			
PCS Test Mode	PCS Test Mode	PCS_TestMode [ConnectionChannelSelector]	Enumeration	0x00000000	PCSTEST_NORMAL	
				0x00000001	PCSTEST_PRBS7	
				0x00000002	PCSTEST_PRBS9	
				0x00000003	PCSTEST_PRBS15	
				0x00000004	PCSTEST_PRBS23	
				0x00000005	PCSTEST_PRBS31	
				0x00000006	PCSTEST_HIGHFREQDATA	
				0x00000007	PCSTEST_LOWFREQDATA	
XGMII Test Mode	XGMII Test Mode	XGMII_TestMode [ConnectionChannelSelector]	Enumeration	0x00000000	XGMIITEST_NORMAL	
				0x00000001	XGMIITEST_LOOPBACK	
				0x00000002	XGMIITEST_PATTERNGENERATOR	
XGMII Tester TX Packets	XGMII tester transmitted packets	XGMIITester_TXPackets [ConnectionChannelSelector]	Integer			
XGMII Tester RX Packets	XGMII tester received packets	XGMIITester_RXPackets [ConnectionChannelSelector]	Integer			
XGMII Tester Error Packets	XGMII tester error packets	XGMIITester_ErrorPackets [ConnectionChannelSelector]	Integer			

Table 44 – System monitor parameters

16 Protocol Specific Features (GigE)

16.1 Device Connection Control

Ethernet connection configuration parameters specific for GigE devices.

Parameter	Description	Gen< >Cam name	Type	Possible values		Remarks
				Value	Gen< >Cam name	
Gen< >Cam Category: DeviceControl						
GEV Interface Selector	Selects which link to control	GevInterfaceSelector	Integer (Selector)			
GEV MAC Address	MAC address of the logical link	GevMACAddress [GevInterfaceSelector]	Integer (MAC format)	Max: 0xFFFF FFFFFF FF		8 byte integer
GEV Current Subnet mask	Reports the subnet mask of the given logical link	GevCurrentSubnetMask [GevInterfaceSelector]	Integer (IP format)			
GEV Current IP Address	Reports the IP address for the given logical link	GevCurrentIPAddress [GevInterfaceSelector]	Integer (IP format)			
GEV GVCP Port	Reports the GVCP port number for the given logical link	GevGVCPPort [GevInterfaceSelector]	Integer			

Table 45 – GigE connection configuration

17 Multiple Frame Grabber Synchronization

In order to synchronize multiple Frame Grabbers together the following should be done:

1. The Frame Grabbers must be connected together with a harness.
2. One of the Frame Grabber will be defined as master and configured to provide timer pulses to other slave Frame Grabbers.
3. Connected cameras should be set to Triggered mode (camera vendor dependent).
4. [Camera Trigger](#) parameters should be enabled in all Frame Grabbers to provide triggers to cameras.

In order to achieve a synchronized triggering to all the cameras a sync harness is connected to J1 of all the Frame Grabbers. The wiring diagram of the harness can be seen in the diagram below.

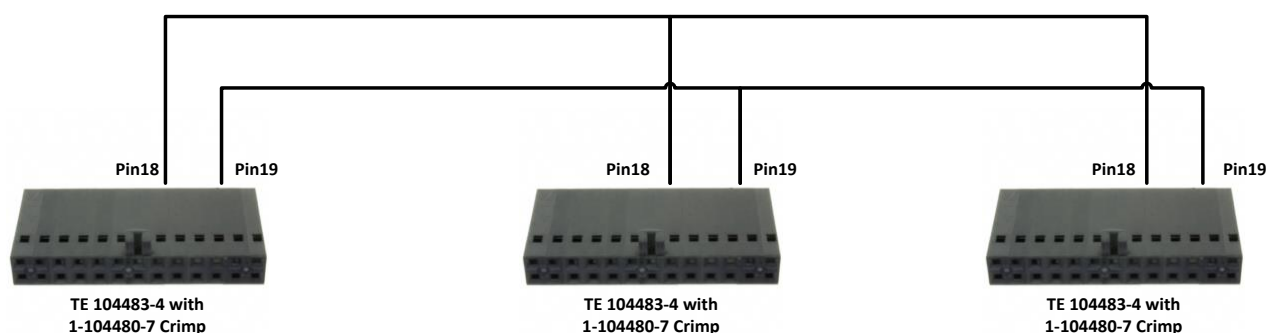

Figure 33 – Frame Grabber synchronization wiring

One of the Frame Grabbers operates as master and others as slaves for camera triggering. The example below shows configuration of three Frame Grabbers for 90Hz frame rate. If other frame rates are needed, the “TimerDelay” and “TimerDuration” values should be adjusted accordingly.

The configuration sequence includes the following steps:

1. Configure timer to generate 90Hz waveform on master card. Please see section 0 for timer description.
2. Configure trigger path for each camera by calling `KYFG_SetGrabberValueEnum_ByValueName()` (for parameters of Enumeration type) and `KYFG_SetGrabberValueFloat()` (for parameters of Float type) with camera handle. Please see section 0 for detailed description.
3. Configure GPIO to synchronize between different boards. Please see section 11.5 for detailed description.

The Frame Grabbers in the control PC should be configured in the following sequence:

Gen<i></i>Cam Name	Type	Card 0 Value (Master)	Card 1 Value	Card 2 Value	Comment
TimerSelector	Enumeration	“Timer0”	NA	NA	
TimerDelay	Float	5555.55	NA	NA	Half cycle for 90Hz
TimerDuration	Float	5555.55	NA	NA	Half cycle for 90Hz
TimerTriggerSource	Enumeration	“KY_CONTINUOUS”	NA	NA	

CameraTriggerMode	Enumeration	"On"	"On"	"On"	For each camera
CameraTriggerActivation	Enumeration	"AnyEdge"	"AnyEdge"	"AnyEdge"	For each camera
CameraTriggerSource	Enumeration	"KY_TTL_0"	"KY_TTL_0"	"KY_TTL_0"	For each camera
LineSelector	Enumeration	"KY_TTL_0"	"KY_TTL_0"	"KY_TTL_0"	
LineMode	Enumeration	"Output"	"Input"	"Input"	
LineSource	Enumeration	"KY_TIMER_ACTIVE_0"	"KY_DISABLED"	"KY_DISABLED"	

Table 46 – Frame Grabber required settings